

DEM 1520LNA, 1500-1650 MHz. High Performance Low Noise Amplifier

Specifications:

Gain:	15dB or 25 dB minimum
Noise Figure:	<0.7dB
IP3 Output:	+30 or +40 dBm min
Input VSWR:	>6dB @ design frequency
Output VSWR:	>10dB DC - 3 GHz.
Voltage:	+10 - +16 VDC



Product Description:

The DEM 1520LNA is one of a new series of low noise amplifiers designed to cover the 800 - 2500 MHz. region. Each LNA is optimized for it's own specified frequency. The new designs are assembled in weather proof enclosures with either type "N" or SMA connectors. This series of LNA are designed for receive only applications. This design is not offered as a bi-directional model. Our LNA design utilizes a single gate GaAs FET that has been developed for high IP3 performance, but still maintains a low noise figures. There are two gain models available. The higher gain LNA has a minimum of +40 dBm IP3 output and doesn't exhibit any degradation in noise figure.

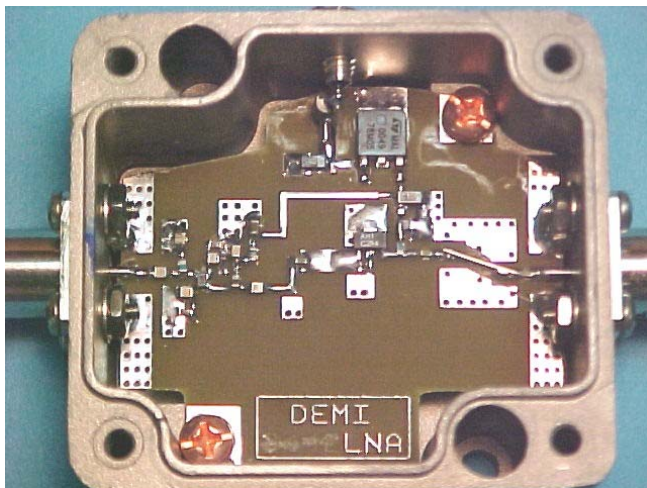

Our LNA low noise amplifier design incorporates a high pass impedance matching network for the noise match and a similar high pass design for the output match. During the test process, the input and out match is optimized for gain and noise figure at the desired frequency. The higher gain model is tested for wide band output impedance. This load impedance absorbs products caused by reflections from band pass filters or high Q receiver front ends. We do not use selective tuned output circuits or baluns in our LNA designs. Tuned output circuits and baluns do not offer constant output impedances over wide bandwidths and may cause out of band instabilities

from reflected signals. Tuned circuits may also require returning if a cable length or the tuning of a filter that is connected to the output of the LNA is changed.

This LNA design is provided with type "N" or SMA connectors that are installed in a weather proof die cast aluminum enclosure that measures 2.5" L x 2.25" W x 1.375" H. This enclosure enhances RF insusceptibility and protects against stray external EMI. DC power is applied through a Pi-circuit feed through filter connector which is a simple solder connection that attenuates frequencies through 18 GHz. It also may be applied through the coax. Specify preference at the time of order. Pricing will depend on the gain and IP3 performance required.

Other LNAs with operating frequencies, configurations, gains and noise figures not found on our price list or product descriptions can be designed by Down East Microwave Inc. and produced with relatively short delivery times. Please contact us with your specifications and/or requirements.

Schematic Diagram of LNA Design:

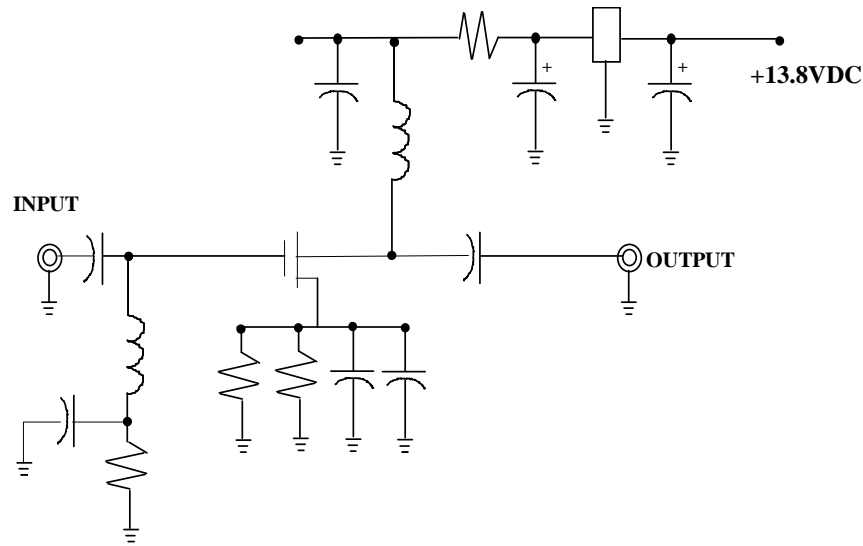

Schematic shown is the 15 dB gain, +30 IP3 output model.