

DEMI Part Number L222-28CK and K Transverter Specifications

Power Out Maximum:	Nominal 25 W linear
Noise Figure and Gain:	>1.0 dB maximum @ 17 dB conversion gain minimum
DC Power Requirement:	11.5 - 15.5 VDC @ 6 Amp Max.
IF Drive Level Maximum:	Range Selectable between -20dBm and 25 watts
Keying Option with/ without Sequencer:	PTT-L (to ground) or PTT – H (Positive Voltage)
User Installed Options:	IF Drive Sense , Negative Voltage Gen., Cooling Fan
	Sequencer, External Local Oscillator

Configuration Overview: The DEMI VHF/UHF transverter line is designed to interface and operate with most High Frequency transceivers that are available on the market today. Since you choose to purchase a kit version, you may configure it to your specifications and interface it with your desired transceiver. This configuration may be changed or altered at any time if you desire to utilize a different transceiver or change you system’s configuration.

DEMI Part Number Verification: All DEMI VHF/UHF transverters contain the operating frequency within the part number, i.e., 222-28CK or K is equated to 222 MHz being converted to 28 MHz. Understand that the conversion is simple math. If you desire to operate on 223.500 MHz. with your 222-28, it will require you to adjust you transceiver to 29.500 MHz.

Power Out Maximum: The maximum **linear** output power indicated on this kit is 25W. This level should not be exceeded if linear operation is expected. The transverter may be capable of producing higher output power but is not recommended because of excessive heating that will interfere with its frequency stability while producing excessive “on the air” distortion products

Noise Figure and Gain: The noise figure and gain listed are nominal minimum requirements and all transverters will exceed these specifications if assembled and adjusted correctly. In utilizing the latest PHEMPT technology, we have designed the complete receive section of the transverter with extra filtering, diplexing, and gain management in mind complete with a RXIF gain control.

DC Power Requirement: The DC power requirement is listed and should be used as a guideline. Please include some “Buffer” in your power supply to eliminate voltage drop delivered to the transverter. Basically, do not utilize a 6-amp power supply for a 6-amp requirement transverter.

RF Option: The 222 Mhz. RF section may be configured with either a single port (Common RF) for both TX and RX or two separate ports, (Split RF) one RX and one TX. There is a PC board



relay doing the Common RF switching. Once configured, the unit may be changed from Common to Split RF if the user desires. It will be covered in the manual.

IF Option: The IF (28 Mhz.) configuration options may be set up as Split IF (separate TXIF and RXIF in/out lines) or can be configured as a Common IF. There is a relay that will switch the RX and TX in the correct direction and is controlled by the PTT circuit.

IF Drive Level Maximum: After configuration, the transverter will operate at its maximum output power with any drive level between -20dBm and 25 watts. The overall drive level range is determined by different attenuators and/or gain stages if required. The TXIF gain control with 15-20 dB of dynamic range will allow the user to tailor a specific output power less than maximum.

Keying Option: The keying options are either PTT-L or PTT-H. PTT-L requires a connection to Ground to transmit. This is the most common keying option. PTT-H requires a voltage between 1.7 and 17VDC to transmit. This option can also be placed on the IF coax if desired. If you desire the sequencer to be utilized, the PTT connection will go directly to the sequencer to key it. In turn, it will key the transverter on the last step of the sequence. Now doing so creates other caveats if you choose to use a High IF drive level (above 1/2W). This is covered in the next section.

User installed Options: The **IF Drive Sense** option should be installed for any Common IF drive level above 100 mW. This circuit is a protection circuit that will prevent excessive IF drive levels from damaging the RXIF circuitry and the Mixer. When utilizing a high- level IF drive transceiver, the IF drive from your transceiver may be applied to the transverter at the same time as the PTT is energized. If the transverters sequencer is utilized, the transverter will be keyed last in the sequence. This would result in the high level IF drive being applied to the transverter's RXIF section which would cause the damage. With the IF drive sense circuit installed, it detects the high-level drive and enables the TXIF attenuator. This protects the transverter's RXIF section and Mixer. It then holds and waits for the Transverter to "Catch up" in the sequence. This circuit will allow a user to key the sequencer circuit with the standard PTT circuit of a transceiver without having an issue or requiring external wiring and modifications to the transceivers PTT circuit. This circuit will also protect the transverter in case the PTT circuit fails between the transverter and the transceiver. If the transverter is keyed directly with the PTT (sequencer is disabled) it will function normally. **CAUTION:** The IF drive sense circuit should not be used to key the sequencer because it will produce long delays between transmit and receive or chop off the beginning of a transmission. The transverter's IF drive sense was designed for protection only.

The **Negative Voltage** option may be utilized by **transceivers without transverter ports** but with ALC inputs to adjust the output power of the transceiver. If the transceiver has an ALC input, this connection can be made through the AUX connector and will be indicated.

The **Cooling Fan** should be installed and used with the temperature sense circuit because it is crucial for frequency stability in digital modes. As the temperature increases the fan speed will increase to provide the additional cooling and frequency stability.

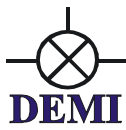

The **Sequencer** is a 4 step circuit that may be used to key any external devices and the transverter itself. It may be configured in any fashion and set up to switch external voltages such as a 24 VDC relay. The voltage may be run into the transverter through the AUX connector and switched through the sequencer.

The transverter has a provision for an **External Local Oscillator** connection. This will be discussed in the text and explained how to either configure a future Synthesized LO or use an external one of your own design.

The KIT Details: This assembly manual calls out a reference to one or two picture numbers for most assembly procedures. The pictures can be found on our website in the "Product Manuals" section. It is a full copy of this manual with all numbered pictures at the end of the document in .PDF format and in color. BUT—for clarity of the pictures, Green wire was substituted with Orange/white wire. You may down load a complete copy of this document or just reference the pictures. You will find that the details offered in the pictures will aid any assemble instruction.

The following component list contains both pre-assembled components and components to be assembled by the kit builder which are in **Bold Print**. Verify that all components in **Bold print** are supplied in the kit. Some Vials have extras components. There may also be component values included in the kit not found on the list. These will be used in the testing section of the document. ALSO, because this is a board used for all transverters from 50 thru 432 MHz, there are some components installed on the circuit board that are not required for 222 MHz operation. They are labeled NA on the component list because they will have no function in your frequency specific version. It is suggested to **Highlight** the components on the component placement document that **are to be installed** as you inventory the values.

DEM 222-28 COMPONENT LIST

Resistors (R) values are in Ohms and are chips unless otherwise specified

R1 1K	R23 470	R40 220	R55 10K	R70 10K
R2 470	R26 24	R41 10K	R56 10K	R71 10K
R3 470	R27 5.6	R42 10K	R57 10K	R72 1M
R4 1.5K	R28 51	R43 470	R58 1M	R73 10K
R5 100	R29 51	R44 10K	R59 10K	R75 100
R6 51	R30 51	R45 220K	R60 220	R76 51
R7 100	R31 12	R46 1M	R61 10K	R77 1K
R8 470	R32 51	R47 10K	R62 10K	R78 220
R9-R15 NA	R33 1K	R48 10K	R63 1M	R81 5.6K
R17 470	R34 330	R49 1K	R64 10K	R82 5.6K
R18 39(1210)	R35 220	R50 5.6K	R65 220	R84 5.6K
R19 470	R36 1K POT	R51 5.6K	R66 10K	
R20 330	R37 220	R52 22K	R67 10K	
R21 150 ½ LEAD	R38 1K POT	R53 470	R68 1M	6T coil for test
R22 51	R39 220	R54 10K	R69 10K	560 & 390 For test

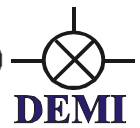

All inductors (L) are in η H and are 1008 chip unless otherwise specified. "PW"=pre-wound or "HW"=hand-wound and utilize enamel wire. All inductors need to be installed in the kit unless specified as **OPT**.

L1 3 Turns #24 HW 1/8" dia	L12 1.0 μ H	L21 1.0 μ H
L2 100	L13 3 Turns #18 3/16" dia HW	L22 330
L3 1.0 μ H	L14 4 Turns #18 3/16" dia HW	L23 150
L4 1.0 μ H	L15 4 Turns #18 3/16" dia HW	L24 220
L7 33	L16 3 Turns #18 3/16" dia HW	L25 150
L8 68	L17 6 Turn small PW	L26 330
L9 68	L18 220	L27 330
L10 33	L19 56	L30 1.0 μ H
L11 1.0 μ H	L20 18	1.0 μ H molded

All capacitors (C) are in pF and are chip unless otherwise specified. "E" = Leaded Electrolytic, "T" = chip Tantalum, Band is positive. NA components are indicated

C1 1000	C39 1.0 μ F T	C63 2-6pF SMD Trimmer	C91 10 or 1000
C2 0.1 μ F 1210	C40 0.1 μ F	C64 2-6pF SMD Trimmer	C92 1000
C3 4 piston	C41 1000	C66 0.1 μ F 1210	C93 1000
C4 1000	C42 1000	C67 0.1 μ F 1210	C94 10 (OPT)
C5 18	C43 1000	C68 1000	C95 1000
C6 24	C44 1000	C69 0.1 μ F 1210	C96 1000
C7 Short	C45 1000	C70 24	C97 1000
C8 0.1 μ F	C46 1000	C71 8	C98 0.1 μ F
C9 0.1 μ F	C47 0.1 μ F	C72 1000	C99 10 μ F T
C10 1.0 μ F T	C48 0.1 μ F	C75 1.0 μ F T	C100 1000
C11 1000	C49 1000	C76 0.1 μ F	C101 NA
C12 1000	C50 1000	C77 0.1 μ F	C102 1000
C13 - 23 NA	C51 0.1 μ F	C78 1000	C103 22 μ F T
C24 1000	C52 100	C79 1000	C104 10 μ F T
C25 24	C53 100 μ F E	C80 1000	C105 10 μ F T (opt)
C26 27	C54 15	C81 56	C106 10 μ F T (opt)
C27 24	C55 18	C82 150	C107 10 μ F T (opt)
C28 1000	C56 15	C83 150	C108 1000
C29- 30,33 NA	C57 1000	C85 150	C112 100 μ F E
C31 1000	C58 100	C86 56	C115 22 μ F T
C32 0.1 μ F	C59 0.1 μ F	C87 1000	C158 100 pF
C34 1000	C60 1.0 μ F T	C88 1000	10pf for test
C35 1000	C61 0.1 μ F	C89 0.1 μ F	
C36 - 38 NA	C62 1000	C90 1000	

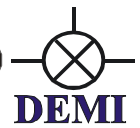
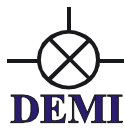

Solid State, Relays and Filter Components

CR1 1N4000 type	IC2 PHA-1	Q8 MJD31
CR2 HSMP3814	IC3 MAR3	Q9 PMBT3904
CR3 MPN3404	IC4 MAV11	Q10 MJD32
CR4 MPN3404	IC5 RA30H2127M	Q11 PMBT3904
CR5 1N914 or 4148	IC6 PHA-1	Q12 PMBT3904
CR6 1N914 or 4148	IC7 MAR6 (option)	Q13 PMBT3904
CR7 HP2800 SMD	IC8 LM393	Q14 MJD31
CR8 HP2800 SMD	IC9 LM324	Q15 PMBT3904
CR9 MMBD914	IC10 7660 (option)	Q24 PMBT3904
CR10 1N4000 type	K1 G5V or D2n	Q26 PMBT3904
CR11 HP2800 SMD	K2 G6Y	VR3 78L05
CR12 MMBD914	K3 G6Y	VR4 78M05
CR13 MMBD914	M1 SYM18H	VR5 78S09
CR14 1N4000 type	Q1 2N5179	Y1 194.0000
CR21 MMBD914	Q2 2N5179	PTC-50 Thermistor
F2 222M-3 pole	Q5 PMBT3904	Xtal Shield
F3 222M-2 pole	Q6 FPD750	Oscillator Shield
F4 222M-2 pole	Q7 PMBT3904	

Verify all of the listed hardware is in the Hardware Kit.

HARDWARE

(1) Heatsink	(1) #6 flat washer
(1) Back Panel of enclosure	(1) #6 ground lug
(1) U-channel enclosure	(1) #4 Ground lug
(1) Bottom panel	(1) 50 Ohm load
(7) Black 4-40 screws	(1) Switch
(18) 4-40 x 1/4" screws	(1) Green LED
(12) Aluminum Shoulder Bushings	(1) Red LED
(10) 4-40 x 7/16" screws	(2) BNC connectors and Hardware
(2) 4-40x 1/2" screws	(2) Type "N" connectors and hardware
(2) #4 flat washers	(1) RCA connector
(2) 4-40 x 1/4" threaded standoffs	(1) 8 pin connector set
(3) 4-40 nuts	(1) NL2 connector
(1) 4-40 x3/8" screw	(1) NL2FC connector
(1) Brass shield for Power module (if required)	(1) 1000pf disc cap
(2) 6-32 x 5/16" screws	(1) 3/4" hole plug
(2) 3/8" hole plug	Coax, 20"
#16 wire, 1.5" black, 2.5" color	#24 gauge wire, 6 feet (Green)
Power meter kit	(1) NTC Thermistor
(1) Fan	(4) 6-32 x 1-3/4" screws
(1) Fan guard	(4) Tie Wraps
Sleeving, 3"	(4) Rubber feet
Tube of thermal compound	4' of RED/BLACK Zip cord
Bundle of precut #26 colored wire	



Circuit Board Assembly:

Refer to the component placement diagram and install all topside components that require soldering on the bottom side of the board. Install VR3, F2, F3, F4, K1, K2, K3, R36, R38, CR1, CR3- CR6, CR10 and CR14. Even though K2 (RF relay) and K3 (IF relay) are to make the common RF and IF connections, (combined TX and RX), separate TX and RX connections to both RF and IF ports can still be made after relay installation. BUT—you may leave both relays uninstalled if you only desire separate RX and TX ports for the IF and RF connections. Be sure to heat the ground connections well before flowing solder on the filters and relays. Cut the excess from all leads flush with the board. **See Picture 1 and 2**

Now examine the Bottom Side Board Assembly picture on the next page. It is suggested to complete all of the wiring on the bottom side. Some wires are for features that you may never utilize in your configuration but will provide ease of a configuration change at a later date if you decide to change transceivers. If you do not see the need for certain features, some of the wiring may be omitted. The signals are marked on the picture. The negative voltage generator, (+9 connection) the IF drive sense (three wires), and the wiring for the RF TR relay may be left out if those circuits will not be utilized. They could be added to the top side if required in the future. All other wire connections are required for full transverter function. Each marked wire shows its approximate length.

Find the 6 foot wind of #26 Green hook up wire, then cut, trim, tin, and install. It is best to cut the wire a bit long (1/4") and trail fit after soldering one end in place. If you are close with the measurements, the wires will fall into place as shown. If the wire is too long they may get pinched during the assembly of the board. One wire, the 9" 13.8V, is only attached at one end for now. Save the extra wire out of the 6' bundle for topside wiring. **See picture 3** for correct technique of wire soldering.

After all wires that you wish to install are installed, (10 max) be sure none of the wires cross any of the bottom side solder connections of the filters, pots, and RF relays. This is to prevent any RF signals from coupling to the DC connections. The exception is the 2-1/2" TXON wire for the TR switch. It crosses under K1 which is a non-RF circuit relay. Also be sure that the wires do not cross any mounting holes. Then with a small piece of tape, (any type) attach the wires as shown in the next picture being sure that the wires are laying flat on the circuit board. If you desire to attach other wires or configure the transverter differently, or desire to use any type of adhesive to hold wire in place, please do so. Just be sure to clear all mounting holes and exposed RF circuits and do not allow an excessive amount of adhesive to prevent the circuit board from attaching flat to the mounting hardware on the heatsink. A 1/8" clearance is required between the board and heatsink.

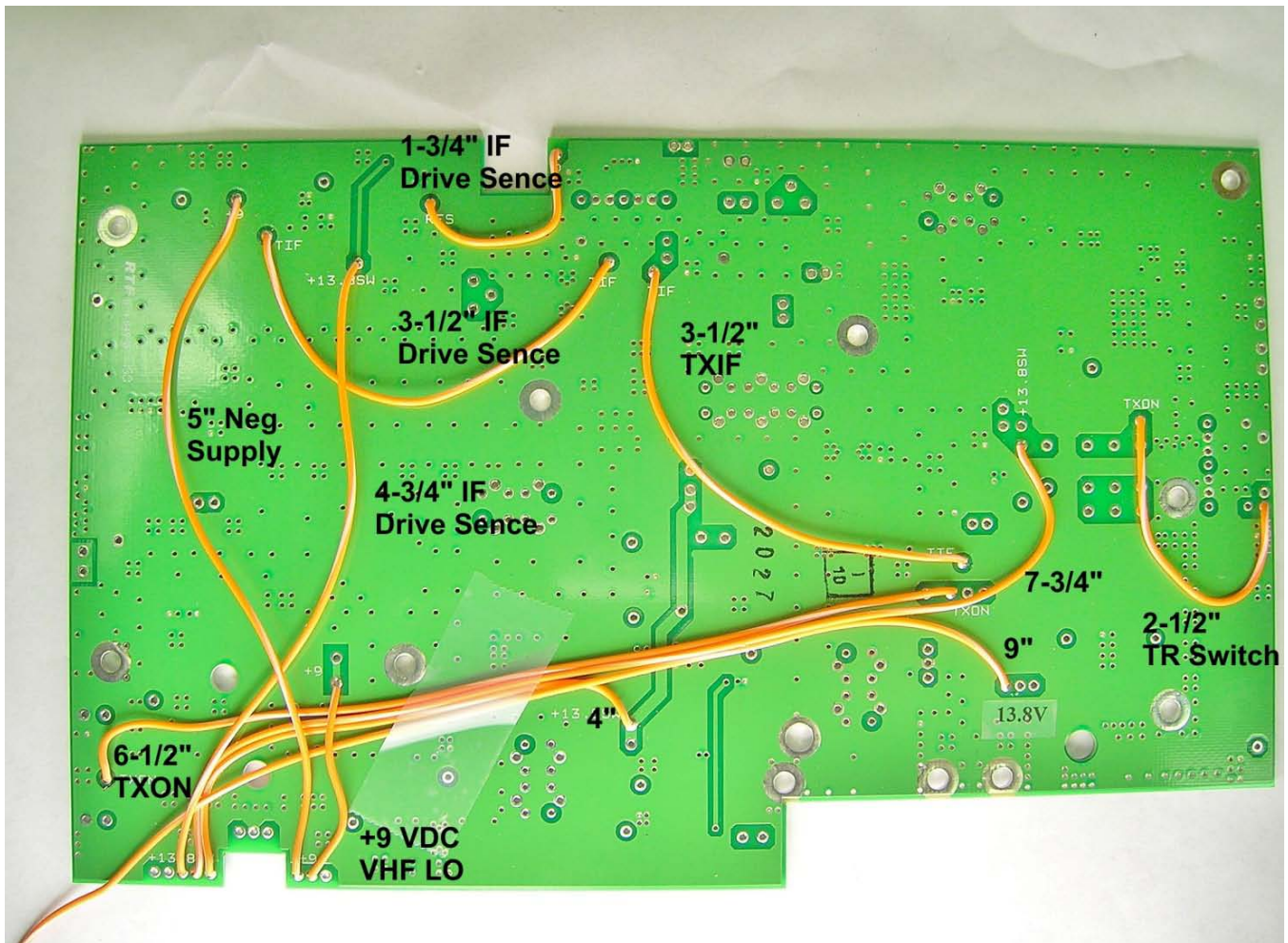

Bottom Side Board Wiring

Surface mounting assembly of components:

The rest of this document assumes that you have the complete kit version. If you have the basic PC board kit, follow along in the instruction manual but skip the instructions that do not pertain to your final assembly.

First, examine the board. It is a basic rectangle with two small notches and one large notch on one corner. If you hold the board so you can read the majority of the screened text left to right, you will find the large notch on the lower left hand side of the board. This is the orientation that the top side component placement document will refer to. In brief, the TX chain and power amplifier is in the lower left, the RX LNA in the upper left, the Local oscillator on the lower and center right. The IF Drive sense and Negative voltage generator are on the upper right. The upper center of the board is the IF section and the lower center is the sequencer as shown in **Picture 4**.

What is convenient for assembly is that the circuit board may be mounted to the heatsink before any surface mount work is done. But, if you have a PC board vice that you utilize for board

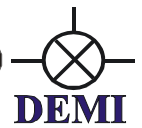

projects, you may want to use it. It is your choice. Since there is no further work to be done on the bottom side of the board, we recommend attaching the board to the heatsink to save a step.

Find the 11 shoulder bushings in the hardware kit and install them in the holes in the heatsink. These act as spacers for the board. Some may fit snug and it is alright to gently “tap” them in. Be sure that they are completely seated. Next locate the position for the NTC as shown on the component placement. It is the largest recessed hole in the heatsink. It requires to be filled about $\frac{3}{4}$ of the way with thermal compound before the NTC is installed and is easier to do before the board is attached to the heatsink. Find the tube of thermal compound, use, than save the rest for the Power module mounting later in the kit instructions. **See picture 5.**

Now find VR5, the 9 VDC regulator. Its leads are mounted through the bottom side of the board. Insert VR5’s leads through the board from the bottom side as far as it will go. Then bend it over in the direction as shown in the placement diagram. Do not solder! Align and place the circuit board on the bushings along with VR5 in place. Be sure the one end of the +13 8SW wire that is not attached is out from under the board on the lower right hand side. This wire is connected to the switch during final wiring. Then verify that the board sits flat on the bushings (no wires being pinched) and attach the board with nine 4-40 x 7/16”, two 4-40 x 1/2” with flat washers and one 4-40 x 1/4” screw for VR5. The longer screws and washers go in the local oscillator section (lower right hand side of the board) and will hold the shield in place after testing. Start all screws first then tighten. Some screws will be removed to ease assembly later during the process and will be specified, but for now, you have a solid mounted circuit board ready for assembly. Solder VR5’s leads in place after all screws are seated. **See Pictures 6 and 7**

It is now recommended to follow the assembly steps listed below but if you are an experienced builder, you may start on the board anywhere you want placing all of the components listed on the component lists. The assembly steps will cover some options and place importance on some order of assembly but again, nothing is critical and does not need to be assembled in any particular order. If you decide to go about this on your own path, the only precaution is if you desire to test the local oscillator for the correct output level, do not install the Mixer, M1. Leaving the mixer un-installed allows testing of the RF, LO and IF stages independently.

1. Install Q1 and Q2 by first cutting the 4th lead off. It is the ground lead and its attached to the can internally. Measure with a ohm meter if unsure of it’s pictorial on the component placement diagram. Cut the other three leads to 1/4” long. Place the cans in the holes on the board as shown on the component placement and solder the cans into place. Then bend the leads in a “Π” shape and attach to the circuit board. You can check the leads for a solder short to ground with an Ohm meter or just do a visual inspection. **See Picture 13**
2. Install C2,C5,C6,C10,C39,L2,L3,L4,L11,L12,CR2,IC2 and R18. Check the polarity on C10 and C39. The band is positive.

3. Wind L1 on a 1/8" mandrel. Cut and tin the leads as shown in pictorial then solder in place.
See Picture 11

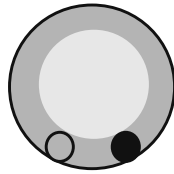

End view of formed coil

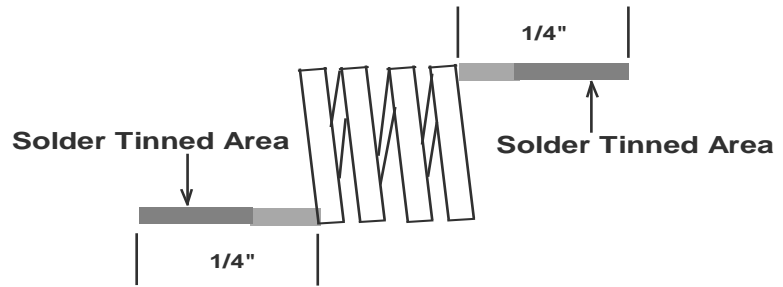

Top view of normally formed coil, (4 turns shown)

4. Solder tin the base of C3. You may use the exposed threaded mounting hole in the heatsink (used for the power module) to hold the capacitor while you "tin" the bottom. Do not over heat. After tinning, place it on the circuit board as shown on the component placement and solder the lead to ground. Then, heat the large pad under C3 and flow the tinned base to the pad. Use extra solder if necessary. **See Picture 12**
5. Prep the leads of the Y1 Crystal as shown in the next group of pictorials. Solder it to the circuit board with the leads pointed at Q1. Prep the PTC Thermistor and Xtal shield as shown. With a solder iron, remove one lead from the Thermistor then solder the Thermistor to the shield. When cooled, bend to shape and place the PTC and shield assembly over the Xtal. Attach the previously removed wire to the side of the shield and connect to ground near R6 with the shortest connection possible. Cut and fit the "Hot" lead and connect the "Hot" PTC wire to the +9 via-hole near the L3 designator on the board. **See picture 13.**

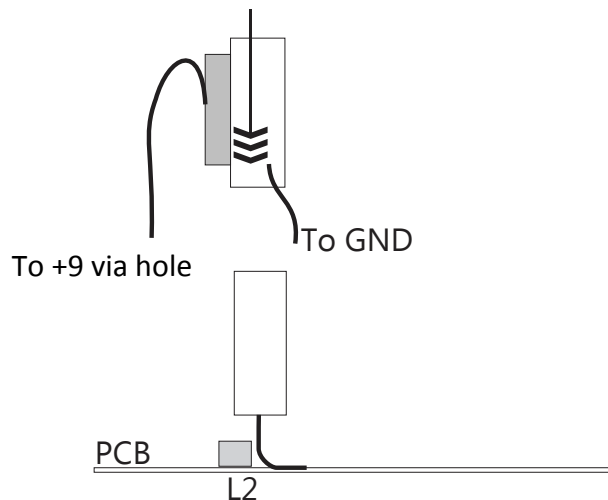
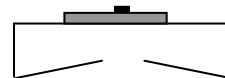
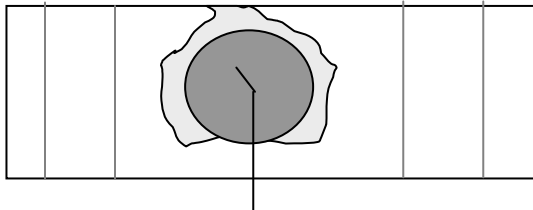

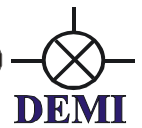

6. Install L7, L8, L9, L10, C25, C26, and C27. This is the local oscillator low pass filter and completes the oscillator. **See Picture 14.** If you wish to test the oscillator level and have an mW power meter, skip Step7. Leaving the mixer un-installed also allows you to test the individual sections of the transverter if you desire. BUT— if you do not have low power measuring capability (less than 100 mw) and accuracy to at least a dB, proceed to step 7.
7. If you do not wish to test the Oscillator level, install the mixer M1. Line it up on the pads and solder. It is best to tin one pad and hold the mixer in place while heating the tinned pad. Solder the other two by flowing solder and then do the ground pads (3) .It will require some heat to flow the ground connections! **See Picture 15.**
8. Next assemble the IF section of the transverter. Install L22- L27. **See Picture 16.**
9. All of the following components listed in Step 9 except for IC7 can now be installed but their utilization is dependent on the IF configuration you require. An explanation of what certain components do follows along with advice if you chose not to install. For further explanation of the IF section, Refer to the “**TXIF Drive Level Range**” section found in the “**Options Setup**” section on page 25.
 - a. CR5 and CR6 are only required for drive levels higher than 1/2W but not required at all if you use separate TX and RX ports. BUT-Having them installed does not inhibit any configuration.
 - b. CR7, CR8, C94 and C99 (C99 is near IC8) are part of the RF sense protection circuit. The circuit is only required for a common IF greater than 1/2W drive configurations but will not inhibit any configuration. Check polarity of C99
 - c. The 50 Ohm load is required with any drive level above 200 mw regardless of any IF configuration. It will provide attenuation at all drive levels so do not install with lower drive levels. Attach one lead to a #4 ground lug mounted to the load with a 4-40 x3/8”
See Picture 17
 - d. C91 should be a 1000pf if the drive level is below 1/2W and 10 pF for all drive levels above ½ watt.
 - e. IC7 is the TXIF gain stage and is only installed if the IF drive level is less than 1 mw (0dBm). If your drive level is close to 1mw, install it after the TXRF testing is complete. Depending on test results, it may or may not be required to compensate for lower or higher TX gains in the RF section of the transverter.
10. If you require the negative voltage generator circuit, Install IC10, C105- C107. These components need to be ordered separately. This circuit provides a negative voltage that is supplied to transceivers that do not have a transverter port or a way of limiting the output power, and of course, have an ALC input. When voltage is supplied to ALC input of a transceiver, it will limit the power delivered to a transverter. It will be discussed further in the set up and operation section of this manual. **See Picture 18.**
11. Complete the assembly of the sequencer by installing Q8, Q10, C103 and C104. Do not mix up Q8 and Q10 and check polarity of C103 and 104! **See picture 19.**
12. Install TXRF gain stage components IC3, IC4, R21 and C60. Surface one lead of R21 (the connection to IC4). Form the lead of IC3 and IC4 before soldering if required. **Picture 20** Then install C53 and C112 by surface mounting the leads. **Picture 24.**

13. Install the TX low pass filter. Place and solder C54-C56 first. Then using the pre-wound 3/16" dia. Coils, install L13-L16. The coils have different pitches so follow the pictorial for installation. **See picture 21.**
14. Install CR11 (lower left hand corner) the power detector diode. Then install Q14 and C115, the fan speed control circuit. **See picture 21.**
15. Begin to install the RX section by installing Q6. Then install C63, C64, L17, C67, C158, C66, C69 and L18. Be sure that C63 and 64 adjust after soldering. **See picture 22.**
16. Complete the diplexer circuit by installing L19, L20, C70 and C71. **See Picture 23.**
17. Finish the RX section by installing IC6, L21, VR4 and C75. **See picture 23.**

Power Module Installation:

Place the power module (IC5) on the heatsink in its mounting location. Trim the leads so they do not extend past the solder pads. They should be approximately 3/8"-1/2" long once trimmed. Remove the Module and wipe the mounting surfaces of the heatsink and flange of IC5, verify the surfaces are free of any foreign matter. Apply a thin even coating of the

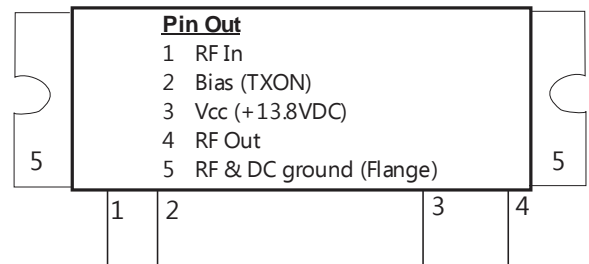

supplied thermal compound to the mounting flange and the heatsink and the bottom of the power module. Place IC5 on the heatsink and "Lap" the thermal compound by moving the module side to side while exerting slight down ward pressure. You will feel the resistance build up when lapped. Line up the leads with the traces of the circuit board. **(Note: If supplied hybrid, IC5, is complete with a silver metal shield, it will not require the brass shield. The silver shield hybrid will not need to be soldered to the**

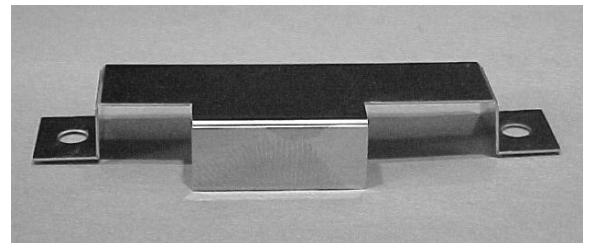

circuit board as the brass one does.) Find the brass shield and form to fit as shown. Using one 6-32 screw and flat washer, install it through the shield and the mounting flange, into the heatsink hole nearest the Q11, 3 and PH3 marking on the PC board. Then install the other 6-32 screw with a #6 Lug in the other hole. Tighten evenly into the heat sink. **NOTE:** Make sure IC5 is mechanically sound to the heat sink because improper seating of the hybrid could result in poor grounding and heat transfer causing damage to the power module. Also be sure that the shield does not shift or contact any of the module leads. The shield front should fit between the module and the part of PC board with the bare metal and two board mounting screws. Form the module leads flat to the traces, and then solder all leads of IC5 to the circuit board. Now observe where the shield contacts the bare metal of the PCB. Tack solder along that edge. It will require a lot of heat so take your time. It helps if you loosen the board mounting screws or remove completely. Just don't fill the holes with solder. Re-tighten when complete. **See picture 24.**

Finally, install the NTC in the hole through the board and in the thermal compound in the heatsink. Attach the leads as shown on the components placement after installing sleeving on the leads. The PCB is complete. **See picture 20 and 24.**

Final Wiring and Assembly

The final wiring and assembly starts with installing the connectors in the rear panel. You may install all of them or only the connectors you will use. All connectors require all supplied hardware. Install the BNC connectors through the labeled side of the panel and place the lock washer, ground lug and nut on in that order. When tightened, the lug should be pointing up in relation to the labeling but angled into the corner. Install the PTT connector (RCA) through the panel, then washer, lug then nut. The lug should point at the AUX connector. The 8 pin AUX connector is self aligning. Install it with the lock ring under the nut. Install the ANT/RX "N" connector through the panel then install the lock washer, lug, and then nut. Tighten nut and have the lug point between the AUX connector and the top of the panel in relation to the labeling. Install the TX "N" connector the same way. Finally, install the DC power connector (flanged black plastic) Position the connector so that Pin #4 is closest to the top of the panel in relationship to the labeling. **See picture 25.**

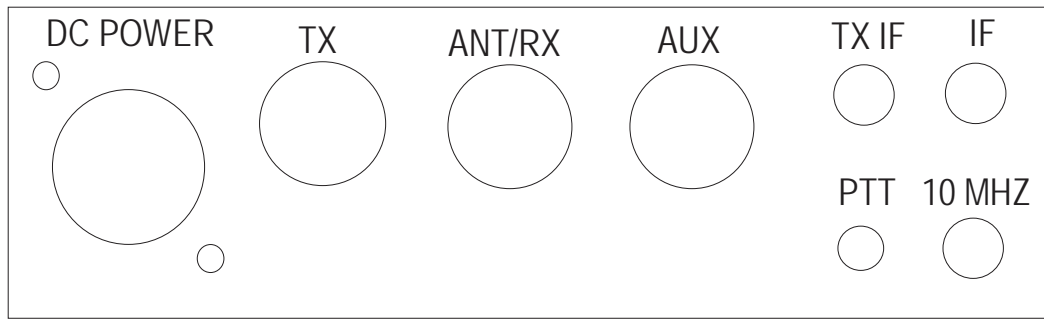

Rear Panel view

Depending on your requirements, Cut, strip, and tin both ends of the coaxes as shown in the next pictorial. Different configurations are explained in the **Options Setup** section at the end of the manual. The lengths of coax are shown below and depend on you specific configuration.

Common IF (the IF BNC Connector)	5-1/2"
RFIF (the IF BNC Connector)	5-1/2"
TXIF (the TXIF BNC connector)	6 1/2"
Common RF (the ANT/RX "N" connector)	3"
RXRF (the ANT/RX "N" connector)	3"
TXRF (the TX "N" connector)	3 "

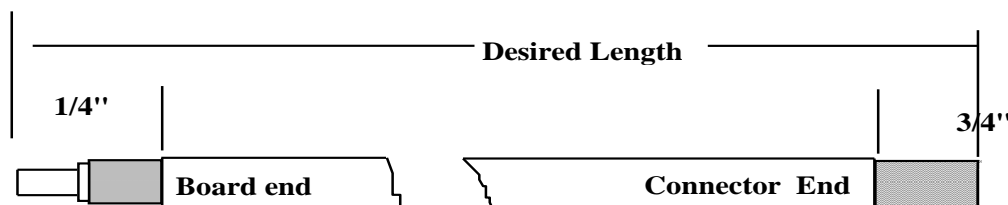

See Picture 27.

Attach the longer stripped end of the coax to the connector as shown in the next pictorial. Push the end through the hole in the ground lug, solder the center conductor to the center pin, then solder the shield to the ground lug. **See picture 26.**

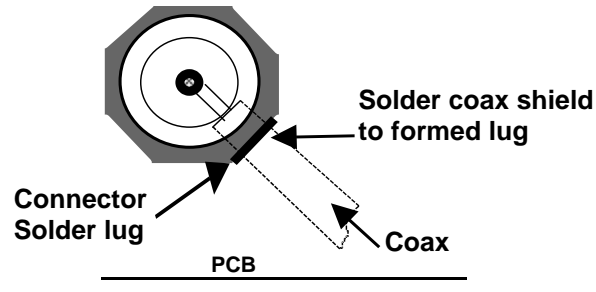

With the pre-cut bundle of colored wire, make wire connections to the AUX and PTT connectors. Follow the wire chart. Strip and tin one end of the wires to 3/16". Tin the connector pins before soldering. All wires are required for sequencer operation and PTT control. **Picture 26.**

AUX Pin 1	11" Orange wire
AUX Pin 2	11" Yellow wire
AUX Pin 3	9" Blue wire
AUX Pin 6, 7, and 8	1-1/2" Black wires (cut from 6" wire)
PTT connector	12" White wire--- Also install 1000pF disc to ground

The DC power connector should now be wired. Attach the two terminals to the 1 1/2" #18 Black wire and the 2 1/2" # 18 orange wire. Strip and tin both ends, 1/4". Crimp is fine, solder is best. Push orange wire terminal on to Pin +1, black on to Pin -1. **See picture 28.**

Place one Ty-Wrap on the bundle of wires less the black ground wires and including the PTT wire as close to the AUX connector as possible. Then attach the rear connector panel to the heat sink using two 4-40 x 1/4" screws. Run the bundled AUX and PTT wires between the panel and the circuit board towards the DC power connector bending them around the corner and behind the Power Module. Strip and tin one end of the 15" purple wire and connect it to the PWR via near CR11 on the lower left corner of the board where the AUX wires wrap around the Power Module. Install a second Ty-Wrap at that point. Now, connect the black wire from the Power connector to the ground lug on IC5 flange. Attach the +DC wire from the power connector to the bare metal marked 13.8V on pin 3 of the power Module. Then Ty-Wrap the bundle to the DC ground wire connection on the side of the power module. **See picture 29 and 30.**

Finish the panel wiring by connecting the short Black wires from the AUX connector (Pins 6, 7, 8) to ground. Insert the three wires into any of the via-holes in the circuit board below the connector. You may scrape some of the solder resist if you feel necessary but it is not required to get a good solder connection. The via-holes are plated through so use a lot of heat to flow the

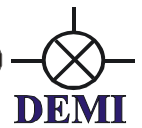

solder. Then begin to connect all of the coaxes to the circuit boards as you have planned for your configuration. If you are unsure of their connections, you may refer to the “**Common or Split IF Option**” and the “**Common or Split RF connections**” section found in the “**Options Setup**” section on page 25 of this manual. There should be a Minimum of two and a maximum of four coaxes. Be sure that the shields are soldered to the board well. It is Teflon coax so do not be afraid to heat the connection! **See picture 29.** Then connect the other AUX connector wires to the sequencer section. Pin 1 to Via 1 on the board, then Pin 2 to 2, Pin 3 to 3. This will provide Pin 1 with voltage on RX, Pin 2 with Voltage on TX and Pin 3 will be a connection to Ground on TX. Trim, strip and tin the wires before connecting. If you desire anything other sequenced signal, consult the Sequencer schematic and its matrix for alternative connections. **See Picture 19.**

The PTT wire may be connected to the PTT – H or L in the sequencer if you plan to use the sequencer or connected directly to the transverter’s PTT –H or L near the K1 relay. This will depend on your configuration plans. If you are using the sequencer, install the 6” White/Org wire from the “4” via in the sequencer to the PTT-L via near CR9. With the left over green wire, strip and tin three 1”green wires and connect two from the +DC to the DC1 and DC2 vias in the sequencer. Connect the third one from the +9 (near VR5) and the +LO via. Strip and tin a 3” wire and install one end in the +13.8SW via near VR5. If you require the negative voltage option, connect an 8” green wire from the ALC via and pin 4 on the AUX connector. **See Picture 31 and 32.**

Begin to Pre-wire the U-channel front panel by assembling the enclosed RFPM kit. This is the bar graph power meter. The board and circuit has been modified and the kit only contains the components (7) required for a positive voltage detection. When completed, install a 2” black wire (GND Connection) and a 6” green wire (+V). Strip and Tin both ends of both wires. You may test the RFPM separately before installing. It requires 12VDC (+ and -) on the two wires and a variable voltage from 0 to 5 VDC on the DET connection. You should be able to vary the voltage and move the Bar Graph display up and down. The Pot will adjust its sensitivity. When complete, find two ¼” threaded hex stand-offs and two 4-40 nuts. Pass the threaded end of the stand-offs through the two mounting holes on the RFPM board so that the threads are on the component side of the board not the display side. Then hand-tighten the nuts. Install the RFPM in the front panel with two 4-40 Black screws. Center the display and tighten the nuts and the screws. **See picture 32.** Then cut, strip and tin the wires on the two LEDs to 2”. Install the Green (ON) LED and the Red (XMIT). Install the switch in the front panel then install the front panel to the heatsink with four 4-40 X ¼” screws and four 4-40 black screws to the rear panel. Start all screws first, and then tighten. It may be necessary to loosen the rear panel a bit to get all screws started. Be sure not to trap any wires under the panel. **See picture 35.**

The front panel wiring starts by connecting the black wire of the power meter to any via hole in the circuit board below. The +DC wire connects to the 13.8SW via near VR5. The 15” purple wire from the PWR via on the board connects to the DET via on the RFPM. Strip, tin and connect. The LED’s are connected next. The Red connects to the TX via and the Green to the ON LED via. There is associated ground vias near each connection. Strip, tin, and solder. Now, attach the wire

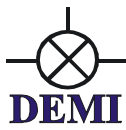

coming out from under the board to the center pole of the switch. Strip, tin and solder. Then connect the wire from the +13.8SW connection to the top lug on the switch. **See picture 32.**

Installation of the Fan Option is recommended for the best possible frequency stability for digital operation. Turn the transverter over so the Heat sink is up. Notice that all of the holes are not filled. There are four 6-32 tapped holes and a large thru-hole. The thru-hole is for the wire of the fan. Feed the wire through the hole and place the fan on the heatsink, label down so that it blow air into the fins. Be sure that the wire is not trapped between the fan and a rib of the heat sink, There is a notch in the fan that the wire passes through. Place the fan grill on it and bolt down the assembly with four 6-32 x 1-3/4" bolts. Make them snug but do not over tighten. **See picture 34.** Turn the assembly back over and dress the wires by Ty-Wrapping them to the sequencer wires near the step "3" connection. Then follow the PTT and DC power wire across the Module. Cut, trim and tin the Red fan wire and attach it to the +13.8V pad with the DC power wire. Continue to route the Black fan wire to the -F pad. Cut, trim and solder. Install a Fifth Ty-wrap to bundle the PTT, +DC and fan wires if desired. **See picture 20.**

Last step before testing is to assemble the DC power cable. They are a little complex but just a great locking connector when complete. First find the NL2FC mate to the flange connector mounted on the transverter. Notice it is 4 parts. The main body, with the Gray lock ring (2 parts). "semi-installed." Do not push the gray ring down covering the contact screws or you will spend some time figuring out how to unlock the cover!! Prep the Red/Black -#14 zip cable by striping and tinning 1/4' on one end. Tin solder both end. Be sure to control the heat (it's not Teflon!) Now, the positive voltage connection is clearly marked on the black body and the gray ring as "1+" the negative or ground connection of the connector is not so clear. Look on the lock tab of the black body. It says "1-". Insert the tined end of the wires in to the clamping holes and tighten the screws. Then it is best to review **Picture 37 and 38** for the correct alignment of the rest of the connector parts because words just can't do it! The tricky part is aligning the three sided wire clamp. It only fits one way and requires some manipulation. After it's inserted, screw down the blue lock nut and then slide down the Gray sleeve. Check out how it mates and disconnects.

Test Section: Before applying DC power to the complete transverter, verify main DC wiring and have a proper fuse installed in the DC power cable or supply. Install some sort of 50 Ohm load on the ANT, TXRF, or RXRF ports. Verify that the PTT port is not shorted. If all looks good, apply DC power and switch on. The Green LED should light and the TX LED (RED) will remain off.

Start by verifying voltages on the board. All voltages should coincide with the DC input voltage from the power supply unless it is on the output of a regulator. There is a voltage matrix at the end of the test section that may be used for checking and troubleshooting. You could verify every point or in general, check VR4 (5 VDC) and VR5 (9 VDC). Verify the +13.8SW voltages and the +DC in the sequencer. Check Pin one in the sequencer for +12VDC or greater. The bias resistor side of IC2 and IC6 should be around +5 VDC +/- . The drain of Q6 (junction of L18 and C69) should be around 3.8 VDC. CR2 is a dual diode and the biased end should be around .8VDC. Verify -F to be somewhere between 6 and 13 VDC depending if the fan is running or not. If

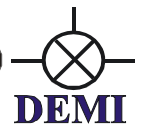

voltages do not fall in line, check wiring or assembly. When complete, shut power switch off. All other preliminary tests are complete and TX tests and will be covered in the TX test section.

Oscillator Start up and testing without mixer installed: If you encounter a problem with the Oscillator, refer to the voltage matrix and verify Q1 and Q2's function. Start by connecting a test coax to the LO input pad of the mixer M1 and ground. This will allow the measurement of the level injected into the mixer. You may also measure the frequency of the oscillator with this connection. Connect the coax to a power meter set to measure 100 mW. Switch the DC power on. The oscillator may just start up or require an adjustment of C3 (the gold piston) to start, then using a voltmeter, peak the voltage for max at TP1 (junction of Q2, C11 and R7 marked on the board) to ground. Verify the output power level on the power meter to be between +15 and +19 dBm. If low, check IC2 for function, missing components in the LO Low Pass Filter, or wire connections. Refer to the voltage check sheet at the end of the test document if needed. If the level is OK and you have a spectrum analyzer, you may verify the 2nd harmonic content. It should be a minimum of -40 dBC (40 dB below the fundamental. If not verify the Low pass filter (the components between C24 and C28). Now, if all tests are ok, you may install the mixer or not and proceed to the General Oscillator testing section. Leaving the mixer un-installed when the Oscillator testing is complete will allow other testing in the TX, RX and IF stages. Installing the mixer when testing is complete will complete the transverter.

Oscillator Start up and testing with mixer installed: If you encounter a problem with the Oscillator, refer to the voltage matrix and verify Q1 and Q2's function. With the mixer installed, you only have the Test point to verify the operation of the Oscillator. Switch the transverter on and verify voltage on TP1 (junction of Q2, C11, and R7). The oscillator may just start up or require an adjustment of C3 (the gold piston) to start, then peak the voltage at TP1 (referenced to ground) to max.

General Oscillator testing: If the voltage peak is towards the top end of the range of the piston (all the way up) spread the turns of L1 slightly and then move the piston cap down to re-peak. Do the opposite if the peak is low in position. What is desired is the Piston to be in the center of its range or slightly toward the top of its range for the peak. The frequency may be checked now but allow the circuit to warm up about 15 minutes. The frequency may be probed at the LO input to the mixer or on the coax if the mixer is not installed. You should be able to adjust to the frequency of the oscillator with C3. For best oscillator performance, it is desired to have the "netted" frequency coincide with the voltage peak on TP1. Because probing TP1 with a volt meter will pull the oscillator frequency down a bit, if the final frequency is within 2 kHz of the voltage peak, it should be fine and skip to the shield installation.

If the voltage peak coincides with a frequency of greater than 2 kHz but less than 6 kHz off desired "Net", it would be best to continue with the transverters final testing and allow a 48 hr burn-in period before retesting. You may find that the frequency may move closer to the voltage peak and the stability may be more than adequate after a 48 hr. burn in. It is suggested to skip to the Oscillator Shield installation, net the frequency and continue with the testing. Then, allow a burn in for 48 hours before retesting.

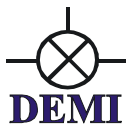

If the frequency is more than 6 kHz of to start with, verify your assembly and the voltage matrix. If all correct, check C2 and R3, the machine assembled component, for soldering or damage. If all look OK, proceed to the Frequency Net Modification. If the frequency is greater than 8 kHz, please consult us before modification.

Frequency Net Modification: If the difference in frequency is greater than 2 kHz after a 48 hour burn-in or as much as 8 kHz before burn-in, you may do the following. First, recheck the frequency vs. test point voltage to verify difference plus determine if it is high or low in frequency. If there isn't more than 2 kHz difference, the modification will not help very much. BUT—anything more than that, improvement can be made. Remove the shield, (if installed) and look for the word "CUT" on the board between Y1 (the crystal) and Q1. **See picture 13.** Cut and remove the trace between the two pads. Remove the crystal from the circuit if you need the room. Now, if the frequency is low, solder a 10 pF chip cap (extra in kit) between the pads. If the frequency is high, solder the HW 6T copper wire inductor (extra in kit) between the same pads. Re-install the crystal and start up the oscillator. Allow warm up time and retest frequency vs. test point voltage. If OK, move on! If it is still off more than 3 kHz, if you decrease the size of the cap, the frequency will move up. If you increase the size of the inductor, the frequency will move down. Feel free to substitute if you have the components. If not please consult DEMI.

Oscillator Shield installation: Power down the board and remove the two 4-40 x1/2 screws and flat washers from the board. Find the shield and line it up with the mounting holes and the piston cap adjustment hole. Gently press the shield down onto the Crystal assembly so that an impression is left in the insulating material in the shield. With a knife, cut and remove the insulation so the shield will fit over the oscillator. The heater wires should make their own path. A bit of trimming may be required for L1 but trial fit first. A snug fit is best. **See picture 36.** When everything fits, bolt the shield down with the screws and washers. Verify that the base lead of Q2 does not touch the shield. If so, re-solder the lead or trim the shield. You will find that the shield will pull the frequency down a bit so re-peak the TP1 or net the frequency after a 5 min warm up and continue with the rest of the testing. **See picture 32.**

Receiver Testing With the mixer installed: Depending on your configuration, the RXRF input port and RXIF output ports will vary. It is assumed that the voltage checks were made and determined to be in spec before the Receive RF test is made. Use whatever means to generate a signal into the RF port (on air signal, signal generator -30dBm or less, or a Noise figure meter) and use whatever 28 MHz receiving device you desire to peak C63 and C64 for maximum gain. **See picture 22.** If you use a noise figure meter, you may find that the best noise figure is not the maximum gain but if you only have gain measurement capabilities, the noise figure may not be optimized but will be close. Be sure to rotate R39 (RXIF Gain adjustment) to verify function. There should not be a need for adjusting the filters and is recommended not too unless you have test equipment that a filter response can be verified on. If 17dB of conversion gain (15 minimum) cannot be achieved, start by verifying voltages on Q6 and IC6 then check kit installed components. Use whatever means to signal trace from input to output to find the problem. Be sure of the RXRF and RXIF configuration and check for shorts on the coaxes and solder shorts on the boards.



Receiver testing without the mixer installed: There should be a minimum of 23 dB of conversion gain depending on the tolerance of the filters and the active components. If you have the ability to check the pass band or then desire to optimize it, do so only with extreme care. The filters have been matched to 50 ohm in/out and a specified pass band response to match the weak signal portion of the band. There should not be a reason to “Re-adjust” but—you can if desired. Just remember that F2, the three pole filter is also a TX filter and is responsible for the rejection of the local oscillator signal that bleeds through the mixer and all products of the LO-IF combination. If testing the RXIF section of the transverter, there should be no more than 3 dB of loss at 28 MHz and will roll off fast above 32 MHz. The low pass filter/ diplexer in the circuit are there to keep all signals above 32 MHz out of your receiver that may be produced within the mixer.

Transmit Testing: If you plan on using the Negative voltage generator to reduce the output power of your transceiver for transverter configuration, proceed to the “**Negative Voltage Option**” test section first. Then come back to this section for the complete Transmit testing.

Depending on your configuration, be sure to have some sort of 50 Ohm load and or RF power meter connected to the designated TX port of the transverter. Preliminary TX testing is done without IF drive being applied. Start by manually enabling the PTT signal (High or Low depending on your configuration). This in turn will enable the TX section and disable the RX section of the transverter through the sequencer or directly depending on your configuration. All relays installed will actuate and the Hybrid power module will draw quiescent current of up to 6 amps. The other TX driver stages and the TXIF amp if utilized will also be biased.

IMPORTANT NOTE: Do not assume that if the output power of the transverter is low that it is because you do not have enough **IF drive**. Please consult DEMI if you have problems obtaining full output power with your specified drive level during the test procedure after you have exhausted all possibilities discussed in the procedure.

Testing with the mixer installed, enable the PTT circuit (without IF Drive) and verify that there is no relay chatter and the total transverter current drain is less than 6 amps. In this state, verify the TX voltages on the matrix. You may notice the fan speed increasing as the transverters TX time is extended. When finished checking all of the TX voltages, un-key the transverter. If there is a problem, find it by checking the wiring first then the kit assembled components. If all OK, rotate R36 fully counter-clockwise (maximum attenuation) and then connect the TXIF drive source. Manually enable the PTT and apply the minimum amount of drive that your transceiver can produce. Verify any output on the power meter. Slowly increase the drive level of the transceiver to the **maximum drive you have configured the transverter for** while observing the power meter. Then adjust the TXIF gain control (R36) to obtain 20-25 watts of output power.

If you cannot achieve any output power, verify opens or shorts starting with the TX output connector then back through the TX section. Look for opens in the Low pass filter L13-L16. If the TR relay is in your configuration, verify its function. You may disable the bias to the RF power module by removing R22. The relay and Low pas filter can then be checked with an Ohm meter. Recheck the TX voltages in the TX chain. Then proceed through the IF section looking for opens or

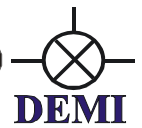

shorts and the function of the TX IF relay if in use. Retest with low drive power first after finding problem.

If the correct amount of power cannot be achieved, (low power) the problem can only be a few things. First check the output low pass filter, L13-L16, C54-56. Verify the windings and you may try to spread or compress the turns for an additional output power. The filter is there to eliminate the 2nd harmonic up so—no matter how you adjust the “L’s” it will not affect the attenuation of the 2nd harmonic but may increase or decrease the insertion loss at the operating frequency. Also verify that the filter components are not heating. (Touch them with RF off) if warm, something is installed incorrectly.

Next suspect the TXIF components. Verify that the Pin diodes CR3 and CR4 are functioning. If the RX gain is OK, the filter diplexer should be OK but you can verify with an ohm meter anyway. Next understand that even if you have configured the transverter correctly, the operating range may be on the edge. Your drive level from your transceiver may not be what was specified. If you have measured and verified it, then depending on your configuration, you may vary the value of C91 if you are using the load. If you are using a low drive level (around 0 dBm) you may need to install the TXIF gain stage. Do not install it if you use more than 5 mW of drive.

Testing the TX section without the mixer is easy. Apply a low level of around -10dBm to the input of F2. Enable the PTT and measure power. Increase the drive to achieve the correct amount of output power. Adjust the output Low pass filter for maximum power. F3 may be optimized but it should not need it. If F2 is tweaked, it will affect the RX section. You may now also check the TXIF section of the transverter. Verify the TXIF gain control and the pin diode switching network. The insertion loss of the TXIF section including the filter/diplexer should be less than 3 dB @ 28 MHz. If all tests OK, you may now install the mixer and either test with your transceiver or your signal generator if desired to verify the complete assembly.

Bar Graph RF Power Meter: While the power meter is connected, the RF bar graph meter calibration can be done. During key down, obtain a 25 watt output level and adjust VR1 on the bar graph to show 9 bars lit. Then vary the power or use SSB to generate RF and follow your speech pattern on the bar graph. Remember that the Bar Graph display is relative and its function may be affected by high VSWR.

IF Drive Sense Circuit: The IF drive sense circuit is a protection circuit only. It should only be utilized with IF drive powers above 200 mW and is only used with a common IF configuration. It will operate at drive levels down to 10 mW. To preliminary test it, you can apply a low level voltage to any RFS via (1-2 volts) and the TIF signal near Q26 should go high. This voltage energizes the K3 relay. The purpose of C94, CR7 and CR8 is to sample and convert the 28 MHz RF energy to DC voltage. To test, lower your IF drive down to the lowest level possible. Then key your transceiver and apply drive. The TIF signal should go high. If not verify the CR7 and CR8 diodes and the RFS signal with an ohm meter. After the transverter is enabled on transmit either through the sequencer or directly by your transceivers PTT, the K3 relay and the rest of the TXIF circuit will be energized by the transverters TXON voltage through the CR21 isolation diode.

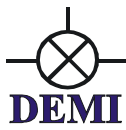

Fan Speed Controller: The fan speed controller should operate on its own speeding the fan up as the transverter heats. You can check the voltage at -F as the transverter is heating. This is the negative lead to the fan and as the transverter increases in temperature, this voltage will move closer to Zero or ground. If you find that the fan is running too early, you can lower the value of R77 from 1K to 910 ohms or even 820 ohms. This also means it will start later in the temp cycle which may affect the frequency stability but its adjustment may increase or decrease the delta in frequency change over temperature.

Sequencer: Testing of the sequencer is simple. Just verify the steps are what it is connected to in both TX and RX modes. If wired as recommended, 1 is positive voltage in RX, open in TX. 2 is open in RX, positive voltage in TX. 3 is open in RX and Ground in TX. 4 is what enables the transverter. It is open in RX and Ground in TX. This is reflected on the matrix on the sequencer schematic. If you wire it differently, use that matrix to note your changes.

For mast mount LNA operation with the basic transverter or with an external high power amplifier, all switching tests should be done without RF applied. Verify that the switching is completed in your desired sequence and gradually add in external components as verified. The last test should be with the transverter's RF applied. All testing can be done without coaxial cables connected. Connect the transverters IF or TXIF cable last.

Step 1 +12VDC on RX for a preamp @ 500 mA maximum

Step 2 +12VDC on TX for a TR relay (around the preamp) @ 500 mA maximum

Step 3 Ground on TX to key a power amplifier. Sinks 100 mA maximum

Step 4 Ground on TX to key Transverter. Sinks 100 mA maximum

Optional Sequencer Connections:

Step 1 and 2. They can be connected to switch higher DC voltages. The DC voltage is applied to the DC1 and DC2 connections on the board (30VDC maximum).

Step 2 TL2 is a secondary connection to the second step. It is a "LOW" on transmit. It can be used to drive a relay or key an amplifier but an external isolation device should be utilized. It will sink 100 mA maximum

Step 3 and Step 4. They have secondary outputs that are both "High" on transmit. They are labeled PH3 and PH4. These should be isolated from devices that require high currents and are intended to drive low current devices or Pass transistors or FETs. They will source 5mA.

The transverter's sequencer may be by-passed to eliminate switching time delays. The external PTT input of the transverter may be connected directly to the transverter's PTT input (see component placement document) near C100 or C102 bypassing the sequencer.

Negative Voltage Option: If you have installed the negative voltage generator option, an approximate -9VDC will be available on the AUX connector pin 4. To set this up with your transceiver, connect pin 4 and one of the ground pins to your transceiver's ALC input. Connect your transceivers output to a power meter and load. With both the transverter and Transceiver

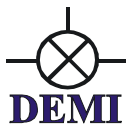

powered on, measure the output power of the transceiver on somewhere in the 28 MHz band to verify that the ALC circuit within your transceiver is operating correctly. With the negative voltage applied, there should be minimum power output (less than 1 watt or as low as a few mW's depending on what type of transceiver it is) With the power meter still connected, if the transverter is powered off, the transceivers output power should come back to normal. Be careful if you are using an mW power meter!! If it all checks out, continue with the transverter testing and installation Connect the RF drive to the transverter and with the transverter switch on, you may then adjust the TXIF drive level in the transverter for your desired output power level.

IMPORTANT NOTE: If you are using the ALC (negative voltage generator) circuit and you desire to use your transceiver for other than transverter use, operating it with the RF/IF cable connected without the ALC voltage running will damage the transverter. What is suggested is to place a coaxial relay (SPDT) between the transverter's IF port and the Transceiver's RF port. Wire the relay so that it directs the RF path to the Transverter when energized. Connect the +13.8SW buss and ground to the relay through the AUX connector.

When the Transverter is switch on, the relay will direct the RF path of the transceiver to the transverter and the transverter will apply the negative voltage to the transceivers ALC port. Power the transverter off will simply switch the transceiver back to normal.

With all circuitry now checked close up the transverter. The TXIF and RXIF adjustments are accessible through the bottom cover. The frequency adjustment is not and it is best not to drill an extra hole for it. This will be explained in the **General Operation, Oscillator** section.

Test Point Matrix

Device/mode	Input	Output	Emitter/Source	Base/Gate	Collector/Drain
Q1 RX	NA	NA	1.4-2.0VDC	1.7-2.2VDC	8.4-9.1VDC
Q2 RX	NA	NA	TP1-Peak	1.4-2.0VDC	8.4-9.1VDC
CR2 RX	0.65-0.95VDC	0 VDC	NA	NA	NA
IC2 RX	0.65-0.95VDC	4.5-5.5VDC	NA	NA	NA
IC6 RX	0.65-0.95VDC	4.5-5.5VDC	NA	NA	NA
Q6 RX	NA	NA	0.35-0.65VDC	0VDC	3.4-3.9VDC
SEQPin1 RX	NA	13-14VDC	NA	NA	NA
IC5 pin2 TX	4.2-4.8VDC	NA	NA	NA	NA
IC3 TX	2.2-2.8VDC	4.5-5.0VDC	NA	NA	NA
IC4 TX	1.5-2.0VDC	5.0-6.0VDC	NA	NA	NA
IC7 TX	2.2-2.8VDC	4.5-5.0VDC	NA	NA	NA
SEQ Pin2TX	NA	13-14VDC	NA	NA	NA
TIF TX	NA	12-14VDC	NA	NA	NA

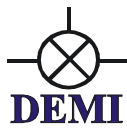

Installation and Operation

Theory of Operation: The basic principle of a VHF/UHF transverter is to convert a chosen band of operation to the 28 MHz. band of a HF transceiver. Following the recommendations of the HF transceiver's operation manual for transverter use is the most important aspect of correct transverter operation. If configured correctly, the transverter will convert both transmit and receive signals to a new band of operation and seem "invisible" to your HF transceivers operation. In simple terms, the transverter will not improve the performance of your HF transceiver but will not cause any degradation of performance in any way.

Interfacing and Operation:

MOST IMPORTANT: When interfacing your transverter, it is recommended that all usable features of the transverter are tested and proven before integrating the transverter into your system. This means verify the transverter functions correctly with the transceiver before interfacing to High Power amplifiers, mast-mount LNA's, and external TR relays. During the initial setup of the transverter, test all switching functions before applying RF. Implement one accessory at a time confirming the switching function, then RF function. Start with low RF drive levels and gradually increase to the final desired level.

It is assumed that since you have assembled this transverter to your specifications, interfacing will be easy. But—we will offer some tips that may have been over looked. Start the interfacing with good quality 50 ohm cables for the IF (28 MHz.) connections. These connections may be low level or at the 25 watt level depending on your configuration and good quality BNC type connectors with adapters to your transceiver are fine! The shielding quality is important to prevent other 28 MHz signals from "Creeping" into your transceiver.

All transverters will require a PTT (to ground or positive voltage on TX) to enable the transmit mode of the transverter. The PTT input to the transverter is a RCA connector. This cable does not need to be shielded, but extra protection in a QRO station is a good idea! Most transceivers have RCA connectors for PTT outputs but others have various connections. Be sure to have whatever cable that is required ready to go.

The DC power cable should be connected to the desired power supply. If you require a longer DC power lead, consider moving up one gauge to eliminate a voltage drop problem. Plan on 6 amp current drain and please fuse the line.

The AUX connector will contain all sequencer connections and any other special requirements such as the negative voltage or any other inputs or outputs you desire. The matching connector to the AUX connector is supplied and should be wired before final interfacing.

If using a mast mount LNA, the IP3 performance of the transverter will be limited by the LNA and total system IP3 performance will be degraded. The amount of degradation will depend on the performance characteristics of the LNA. Yes, the total system gain can be controlled by the RXIF gain control but the dynamic range of the transverter will be reduced by the amount of gain of the LNA at the minimum. Such a system should have the capability of switching the mast mount LNA out of the system. Use of an "In the Shack" LNA in front of the transverter is total nonsense! If you believe your system is lacking gain and the transverter is in spec, find the problem in your

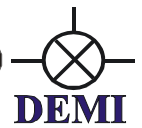

transceiver or antenna system. If you must, you may install an IF amplifier on 28 MHz so not to degrade the transverters "RF" performance.

Another suggestion is if you are to use a mast mount preamplifier, you may consider bypassing the transverters LNA. It requires removing R31 and R26 from the circuit. Then move the RXRF connector cable to the C68 pad. This will utilize the diplexer and first filter in the receive chain and disable all DC power to the Q6 FET.

Unless you have ordered a special order Crystal, the national calling frequencies will be on 222.100 or 28.100 MHz on your IF transceiver. Use of the transverter outside of the Weak Signal portion of the band is possible but slightly degraded performance may be expected. The transverter is designed specifically for the weak signal portion of the band.

Setting your final output power of the transverter is recommended to be done in the CW mode. BUT—verify that if you change modes of your transceiver, the drive levels do not change or overdrive may occur in the SSB mode causing undesirable effects on the band!

The bar graph display is a relative power meter and is driven by the directional coupler and RF detector circuit found in the Low pass filter section of the board (CR11, R76,R75,C108) RF is detected and converted to DC voltage and conducted to the Bar graph display on the front panel. If you find that you operate the transverter at any other level than what it is calibrated to you may change it by adjusting VR1 on the display board. Also remember being that is a reference meter, if your VSWR should increase, it may or may not show an increase or decrease on the bar graph display.

General Operation: General operation of the transverter, if everything is adjusted correctly, should be transparent to the transceiver and the user. Except for the frequency read out, (if your transceiver doesn't allow its display to be adjusted for transverter operation) it will be like operating on 10 Meters. All of the functions of the transceiver (filtering, DSP, split band operation, dual VFO) will be transposed to the frequency band of the transverter.

Some cautions should be taken when operating CW or VOX. Operating the transverter in a "Full Break-in" mode is not recommended. Because of the mechanical relays in the transverter, there will be too much delay to operate "Full Break-in" effectively. AND—the relays would be abused if "Full break-in" is enabled. It is best to operate in "semi break-in" and adjust the delay of the PTT on your transceiver to match your comfortable CW operating speed in a way that the delay will hold the PTT until your transmission is complete. If you have implemented the sequencer, its delay will need to be longer to allow all components within the system (Power amplifier, LNA, relays,) to complete their transition if utilized. If just the transverter is to be used alone, the transceiver PTT signal may be connected directly to the transverter's PTT input bypassing the sequencer. This will shorten up the delay but will still not allow "full break-in" without relay chatter.

General Operation, Oscillator: The transverter will experience frequency drift through aging. Even if you took time to "Net" the frequency of the transverter's local oscillator at its normal operating temperature after a long burn-in, frequency shift from ageing may still cause a need to be re-adjusted after prolonged operation. This is because of the physical nature of crystal ageing

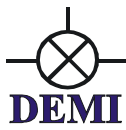

through temperature cycling. As the hours of operation time increase, this “Zero Offset” frequency will be less and less and eventually will not require adjustment.

As for frequency drift during operation, great care has been taken to minimize it in the design. The oscillator section of the transverter board is “Ovenized” and the speed of the cooling fan on the heat sink is controlled by the actual heat sink temperature. The problem still arises from the internal air temperature of the transverter and the heat conduction of the heat sink to the oscillator section of the transverter board. The frequency drift the transverter exhibits may not be noticed on SSB and CW operation. But, a careful understanding of how much “drift” the transverter exhibits and in what direction it moves is important for digital mode operation.

Our testing of this design was done with 30 second transmit and receive times at the transverter’s full rated output power. After a 10-15 min warm up time, we have found that the most extreme drift will occur during the first few transmissions while the transverter reaches its stable internal operating temperature. If the room temperature is less than 75 degrees F (approximately 25 degrees C) the cooling fan may be running slow or not at all. The first or second transmission will cause the Fan to cycle and if the heat sink temp rises enough, it will remain running. The first cycle will cause the largest frequency shift. The next 3-4 transmissions will stabilize the frequency drift. At the 5th or 6th transmissions, the frequency drift will settle down to be 1-2 Hz or less if all conditions remain the same during 30-second cycles. Of course this may be better or worse depending on the transmit power and duty cycle. An operation recommendation would be to start your digital Sked a few minutes early and you will achieve frequency stability at the actual start time of the Sked. Realistically expect 50 Hz total drift. Some factory production units have achieved less than 30 Hz

What is expected to keep the frequency drift to a minimum is to be sure all un-used connector holes in the rear panel either have connectors or holeplugs in them. The IF adjustment holes on the bottom cover plate may remain open but the addition of extra holes or enlarging the existing ones will affect the cooling.

Removal of the fan from the transverter will allow the transverter to drift as much as 500 Hz over a ½ hr. 30 second cycle schedule. This may be acceptable for SSB and CW operation but we have found the ambient fan noise of the transverter to be un-noticeable so if you desire to operate with a digital mode, install the fan. AND—the opposite goes for adding an extra fan. It will not help the “Balance” of heat and air and most like cause excessive drift. But, feel free to experiment if you desire.

Examine the fan control circuit schematic. Voltage from the NTC Thermistor drives the NPN transistor which in turn drives the Pass transistor on the negative lead of the Fan. R77 controls at what temperature the fan starts. The larger the resistance, the lower temp the fan starts at. BUT—if you find that in the TX mode, the heat generated causes excessive drift, the –F connection may be connected to the open contacts on K1 so that the fan operates at full speed during TX. Simply, make the relay’s common connection to ground and run a wire between the NO contact and the –F connection. The fan will now run at full speed during TX and its thermal speed on RX. Understand that there is a delay in heat transfer and that the heatsink still heats up after the transverter is in the RX mode.

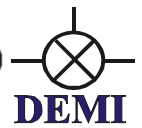
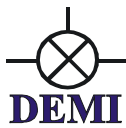

Options Setup:

Common or Split IF Option: The IF configuration may be change at any time according to the type of transceiver you are utilizing. Refer to the Component placement or schematic for clarification. The component designators are also screened on the circuit board.

K3 is the common IF relay. To split the IF lines into separate RXIF and TXIF, remove the IF coax from its position on the board (junction of C93 and C94) and re-attach the center conductor between C95 and K3. You may need to scrape a little solder resist from the pad before soldering. The shield may be now soldered where it was on the ground pad marked COM. The TXIF cable can be prepped and soldered to the pad between K3 and C92. The shield can be soldered to the ground pad labeled TXIF. Install a BNC connector in the rear panel (TXIF) and attach the TXIF coax. Reverse the procedure if you want to change to or back to Common IF.

Please note that if you have a separate IF configuration, the IF drive sense option will no longer function. It is not necessary with the split IF. It is to protect the RX circuit and Mixer from being damaged with the TXIF drive power.

TXIF Drive Level Range: The TXIF drive level range can be changed at anytime to conform to your transceiver type. Basically, there are three configurations. For high IF drive levels, (250 mW-25 watts) the 50 Ohm load will be installed with a low value capacitor in the C91 position (10 pF or less for 25 watts). Mid level drives between 1mW and 250 mW will not have the load installed and will have a 1000 pF capacitor installed for C91. For the low drive levels (-20dBm to 0dBm or 1mW) IC7 will be installed. If you desire to change the drive level for whatever reason, just duplicate the info above. To install IC7, cut the ribs in the trace before installing. Install a MAR-6 as shown on the component placement. Other MMIC's may be used if your desire but the bias resistor R34 may need to be changed. Adjust R36 to obtain desired level in all cases. The important thing to understand is the IF drive range is wide and can accommodate different drive levels between the specified ranges.

Common or Split RF connections: The transverter utilizes K2 as the common RF relay. It is mounted on the circuit board. The common port is marked ANT on the board. The split RF connections are labeled TX and RX on the board at each end of the relay. There is no need to remove the relay for the split connections. Simply remove C57 and C62 and solder coax directly to the marked pads. So--, depending on which way you are going, install/uninstall cables and connectors as required. Remember, if you have separate ports, they may be combined with an external coaxial relay to provide versatility.

External Local Oscillator or Synthesizer Installation: This is a future option and will be covered in a future document after it has been fully developed. For now, if you wish to experiment with your own design or external referenced stabilized oscillator, the connections are available on the LO section of the board. There is a jumper wire installed between the +9VDC buss (near VR5) and the +LO. A SPDT DC switch may be installed between the +9VDC and the +LO inputs or the +SYNTH buss near C42 and R17. A voltage applied to this point will energize the Pin diode switch (CR2) and allow RF input to the LO circuit through C41. Connect and use as desired. A +3 to +7 dBm input would work well. **See picture 30.**

Power Meter

BAR1 BAR GRAPH DISPLAY

IC1 LM3914

C1 1000 DISC CAP

R1 2.7K 1/4W RESISTOR

C2 100 μ F ELECTROLYTIC CAP

VR1 10K POTENTIOMETER

C3 0.1 μ F DISC CAP

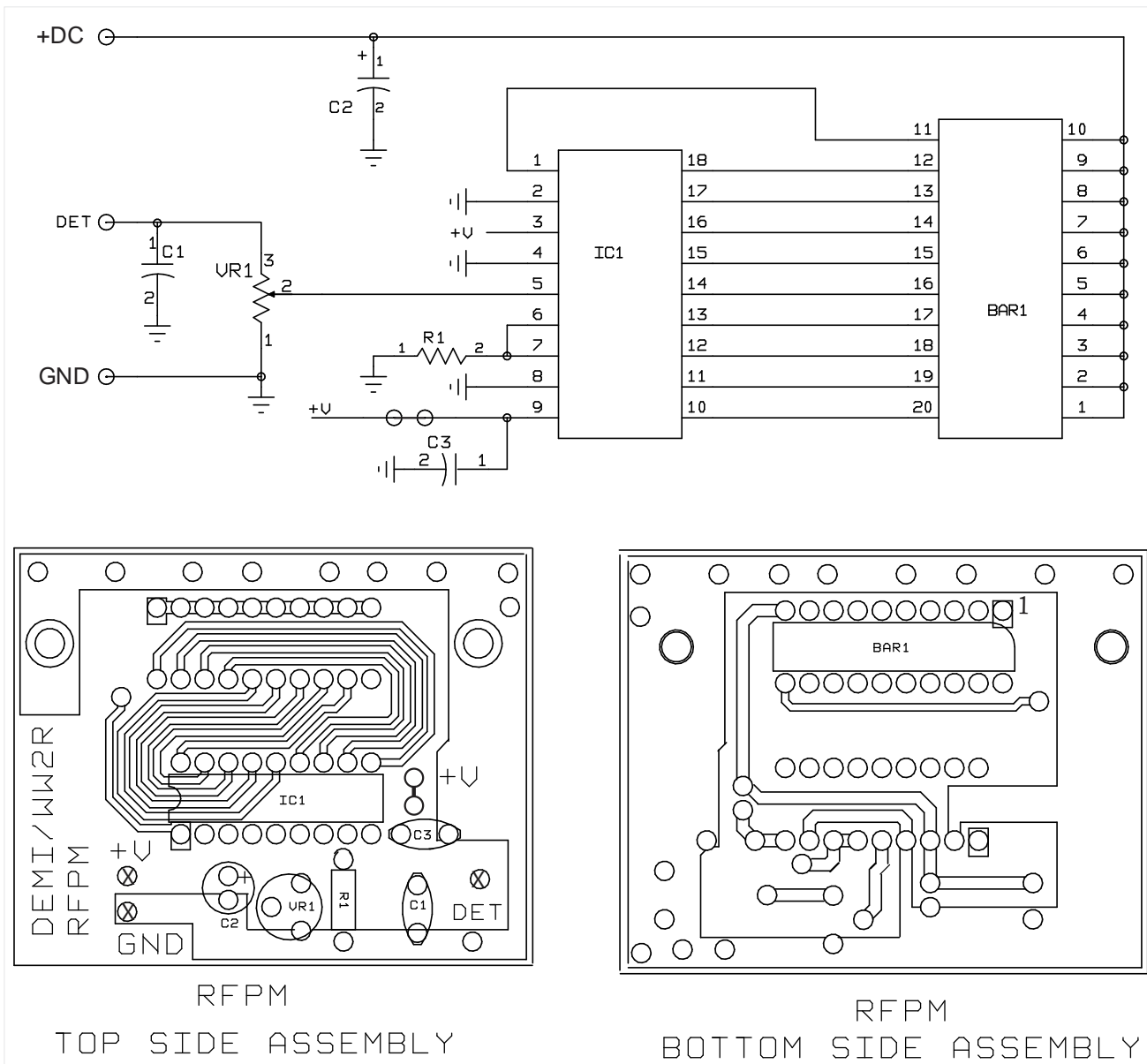

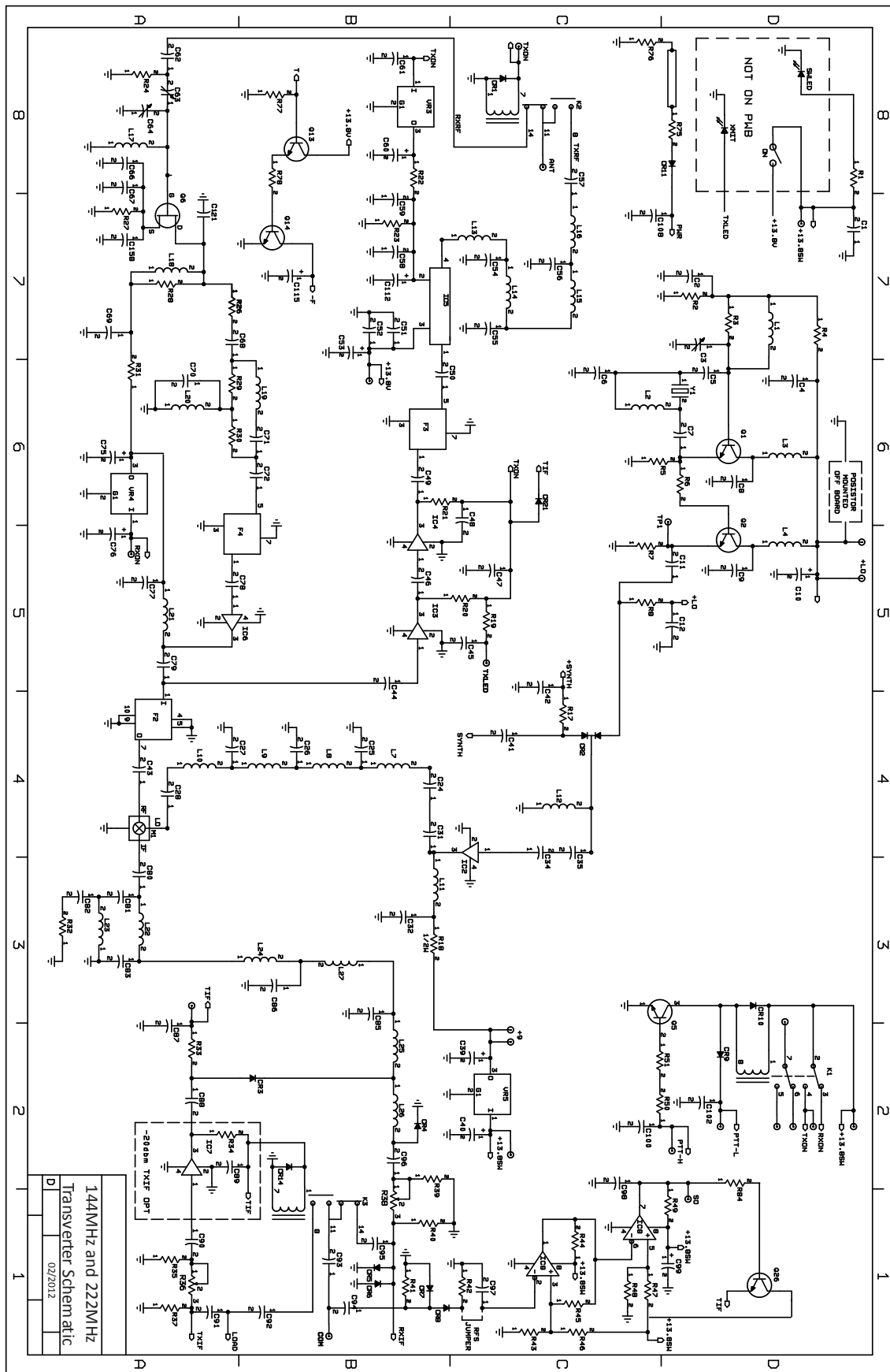

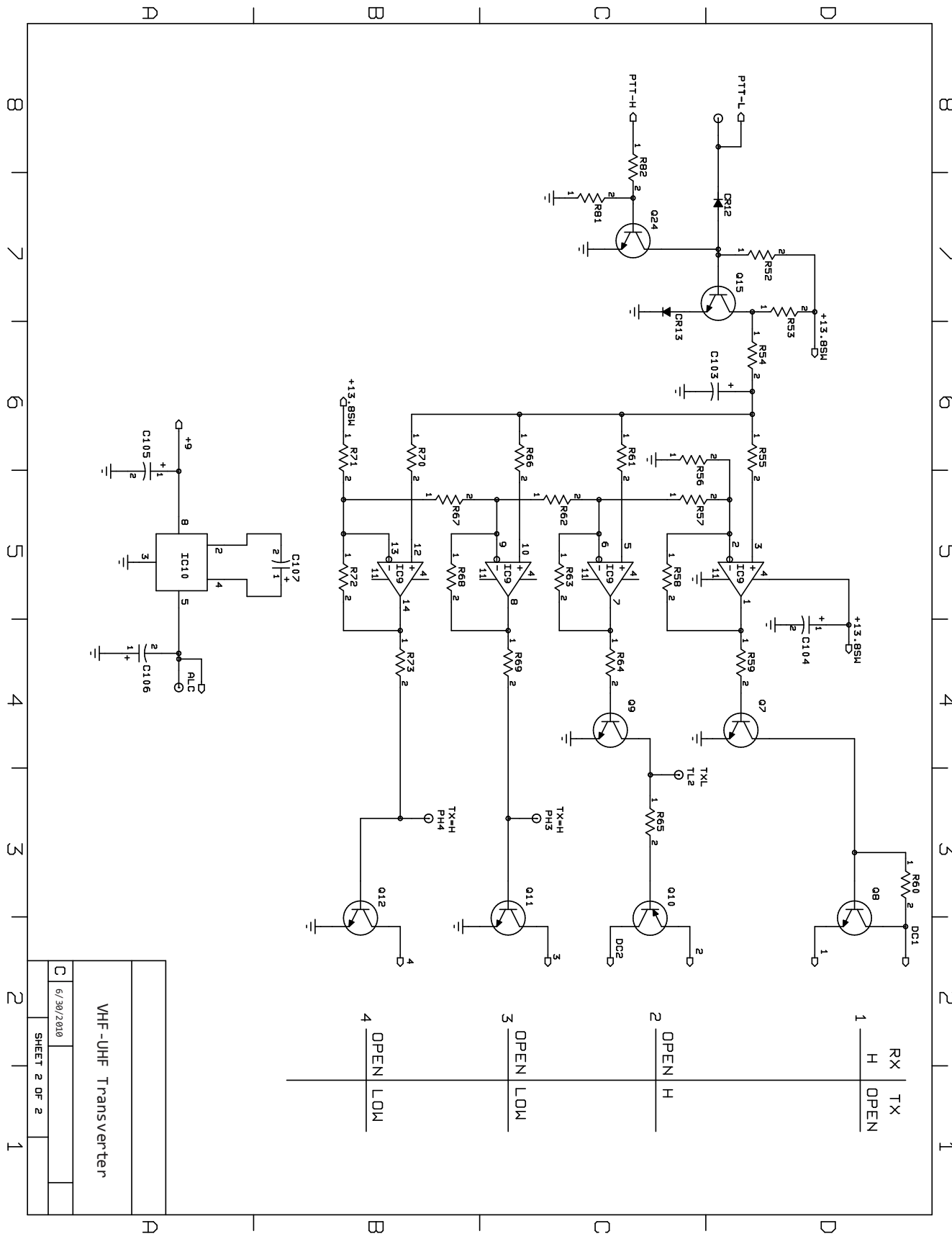
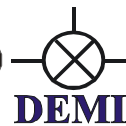
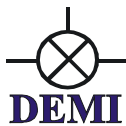

VHF - UHF Transverter	
C	6/30/2010
SHEET 2 OF 2	

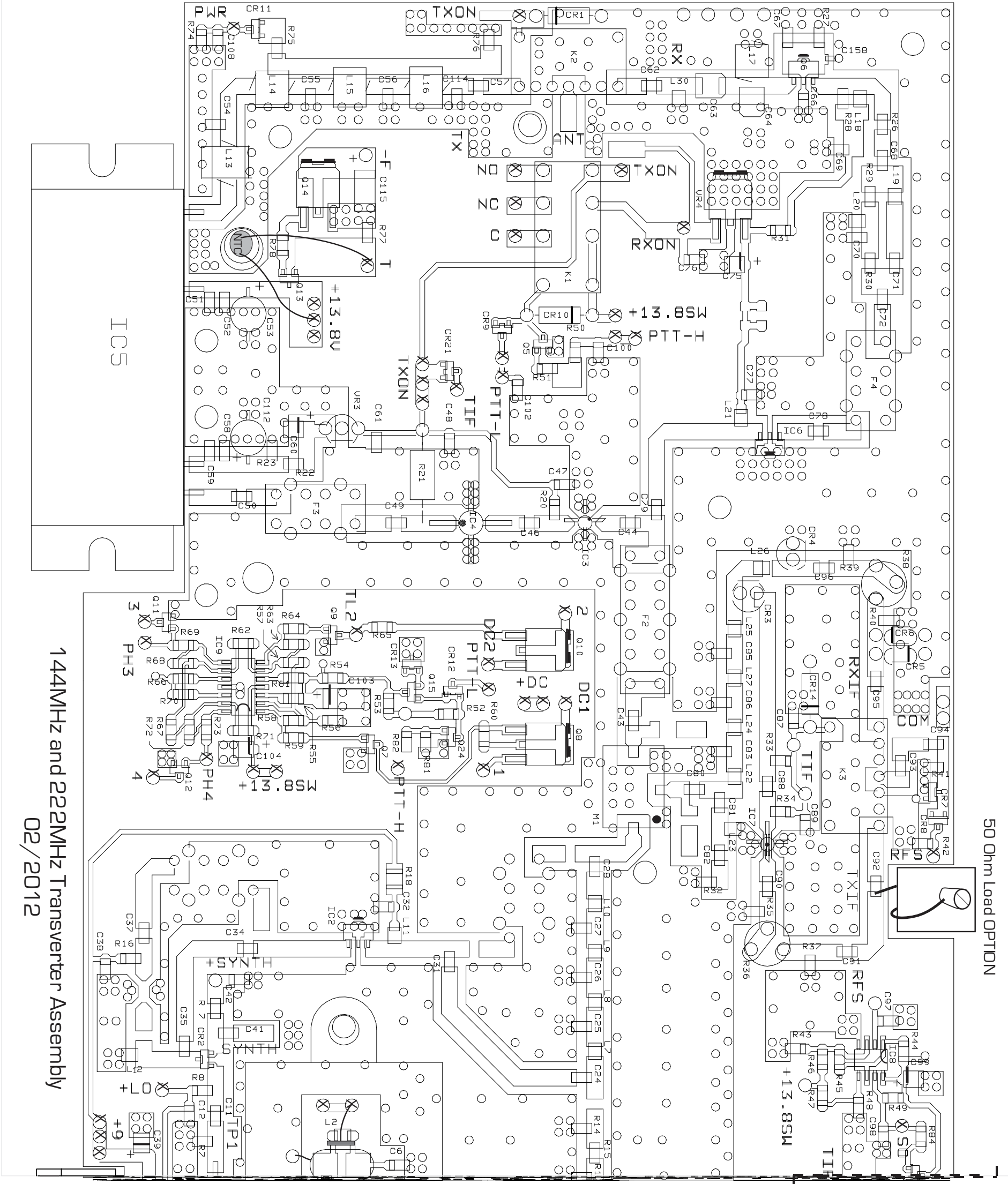

144MHz and 222MHz Transverter Assembly
02/2012

50 Ohm Load OPTION

OPTION

X X X X X

X X

X

X X

X X

1. Proper Filter soldering on bottom side.

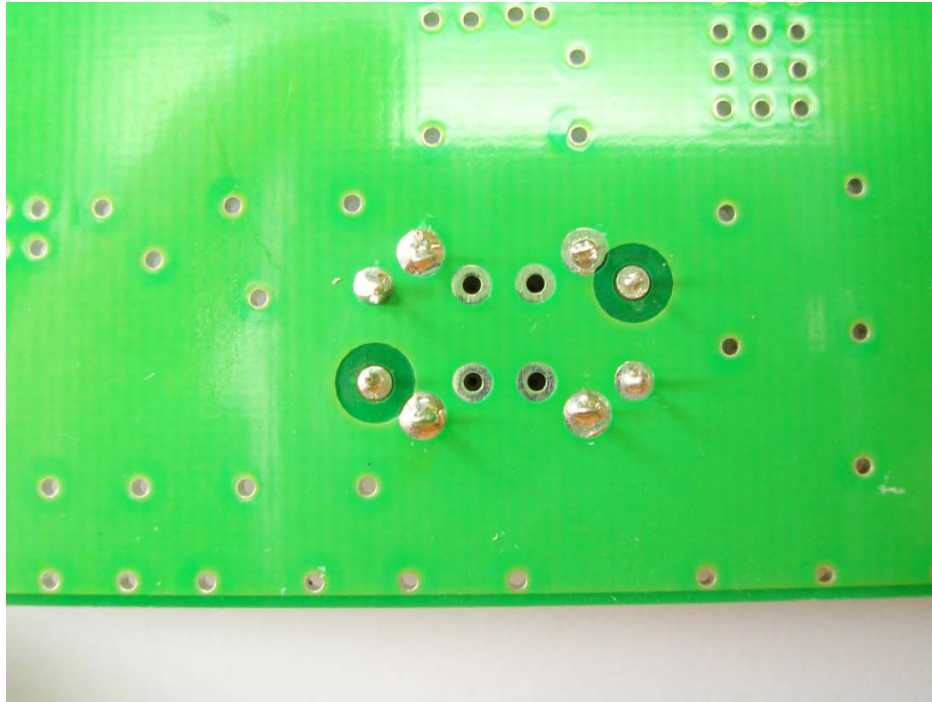

2. Some bottom side soldered, topside components.

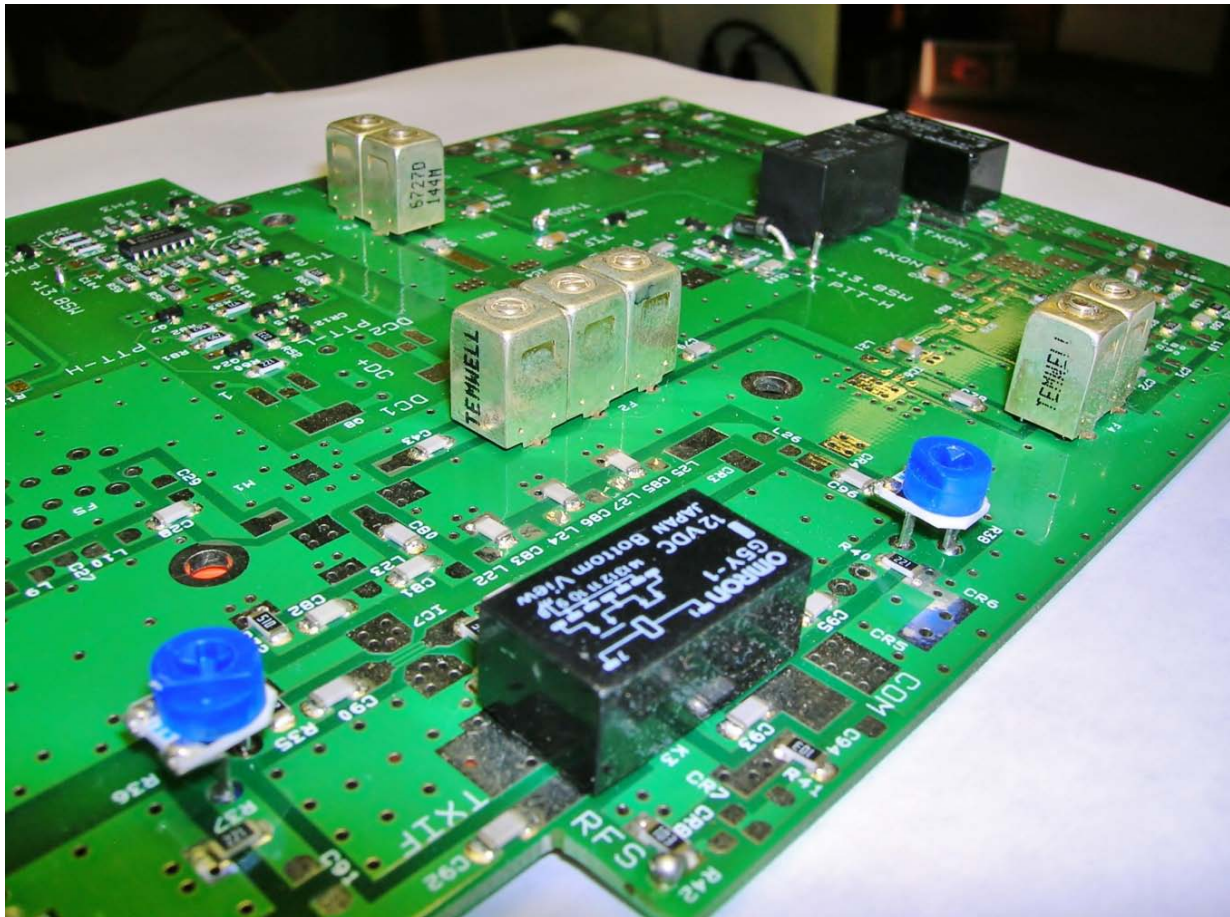

3. Correct wire soldering with solder mask.

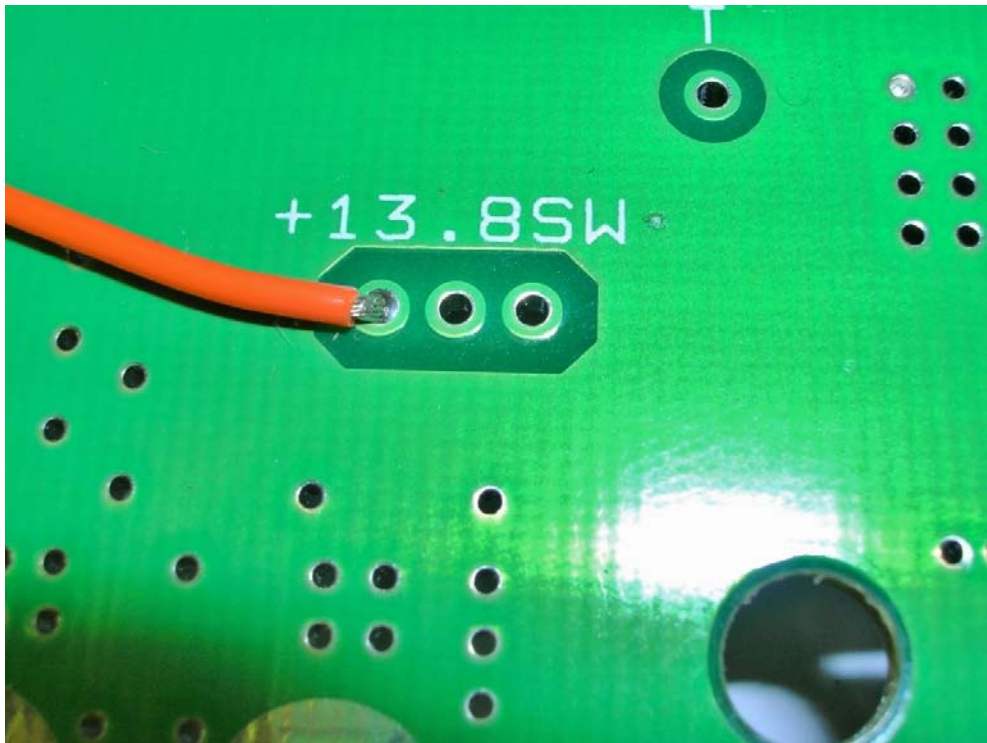

4. Topside board layout and labeled sections.

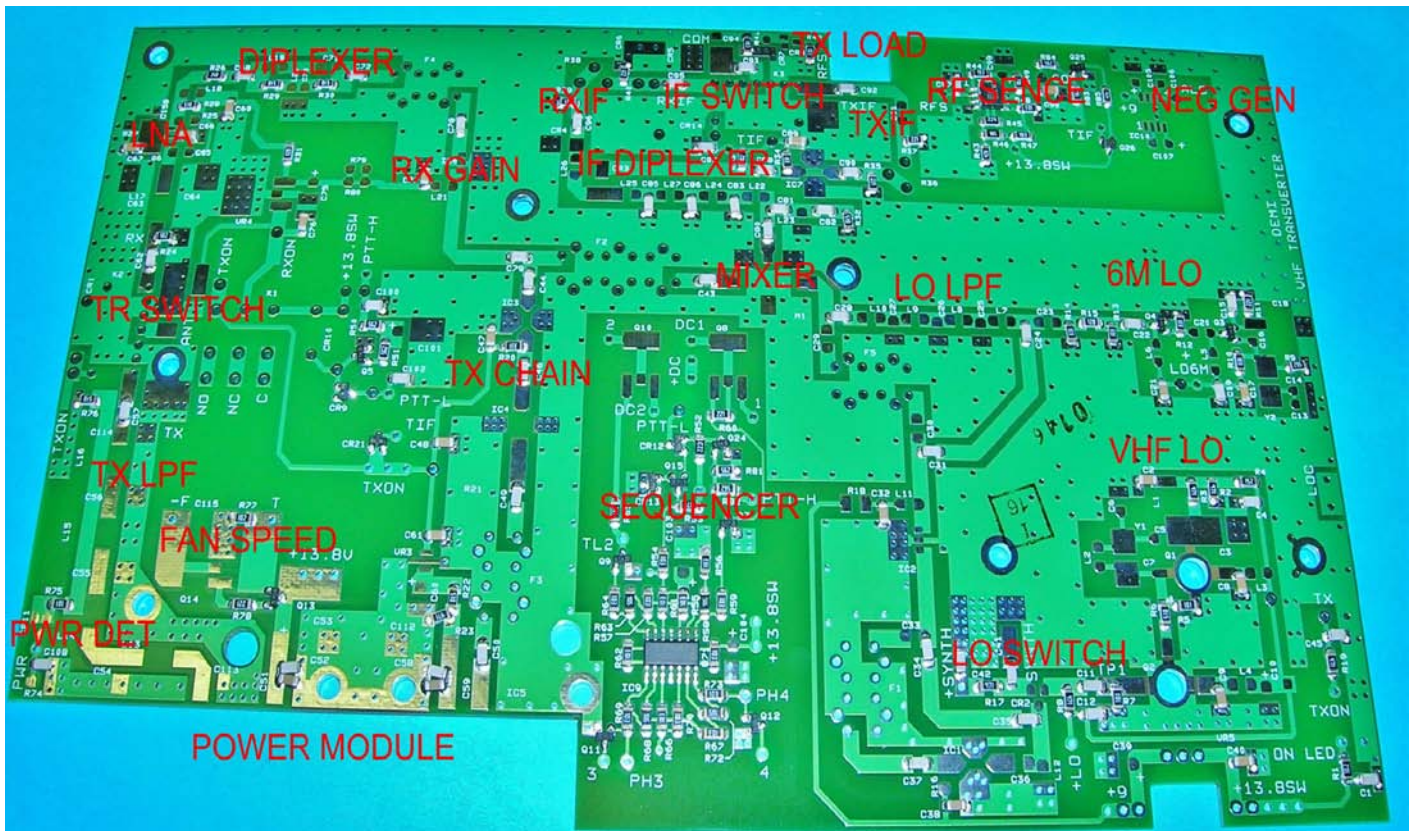

5. Shoulder bushings and NTC hole with thermal compound.

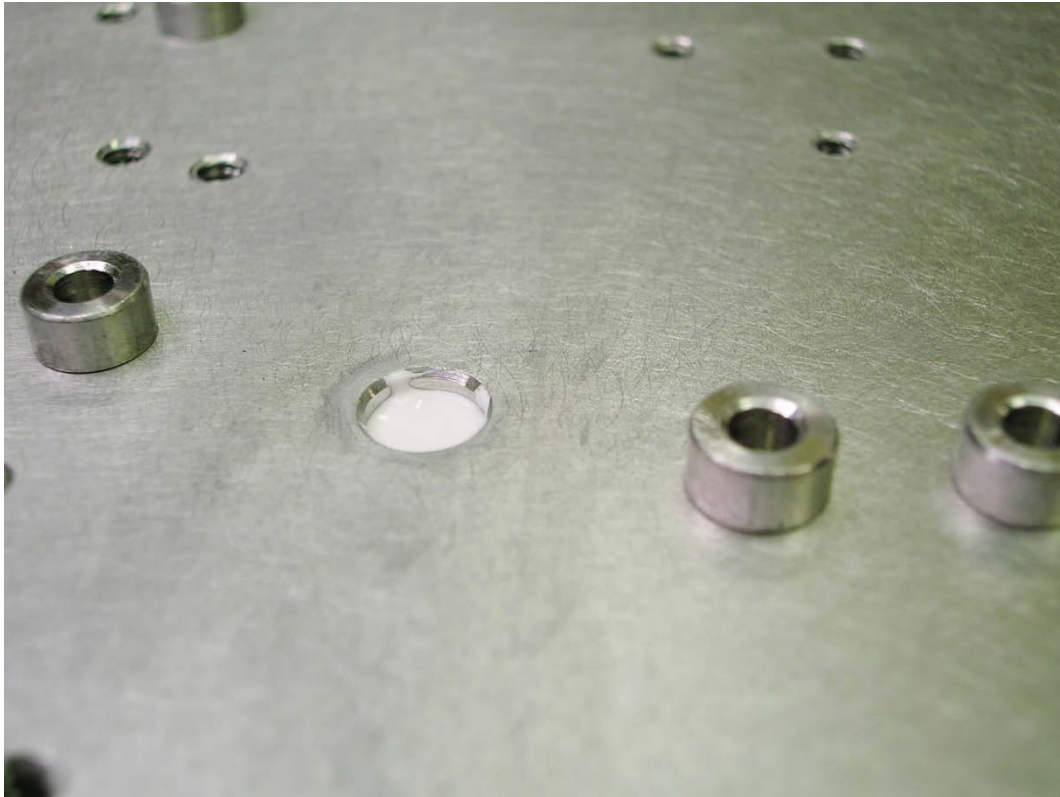

6. VR5 and PCB mount.

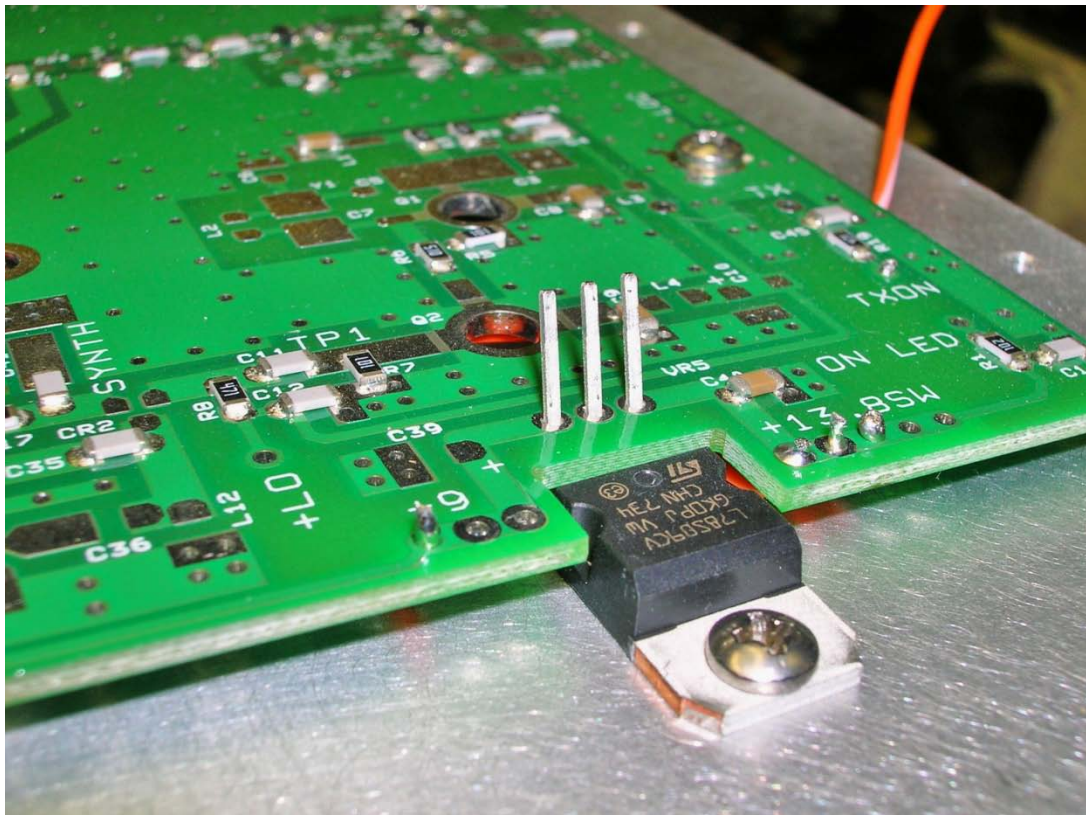

7. PCB correctly mounted.

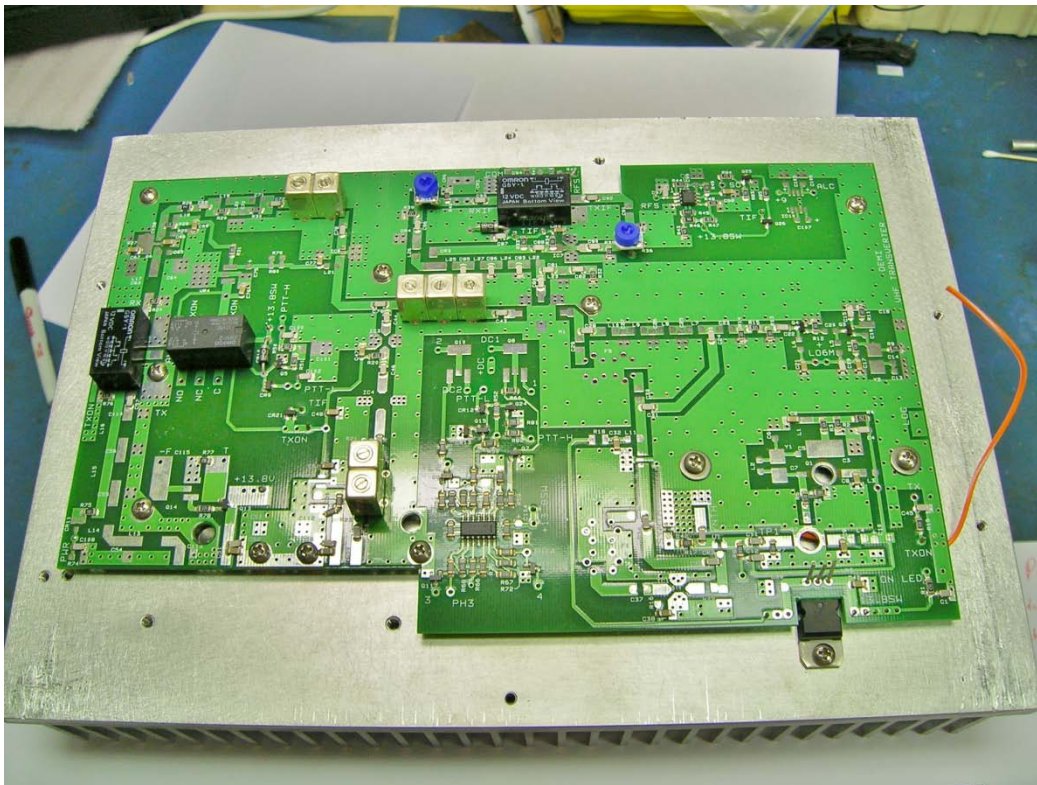

10. The correct Q1 and Q2 pre-assembly.

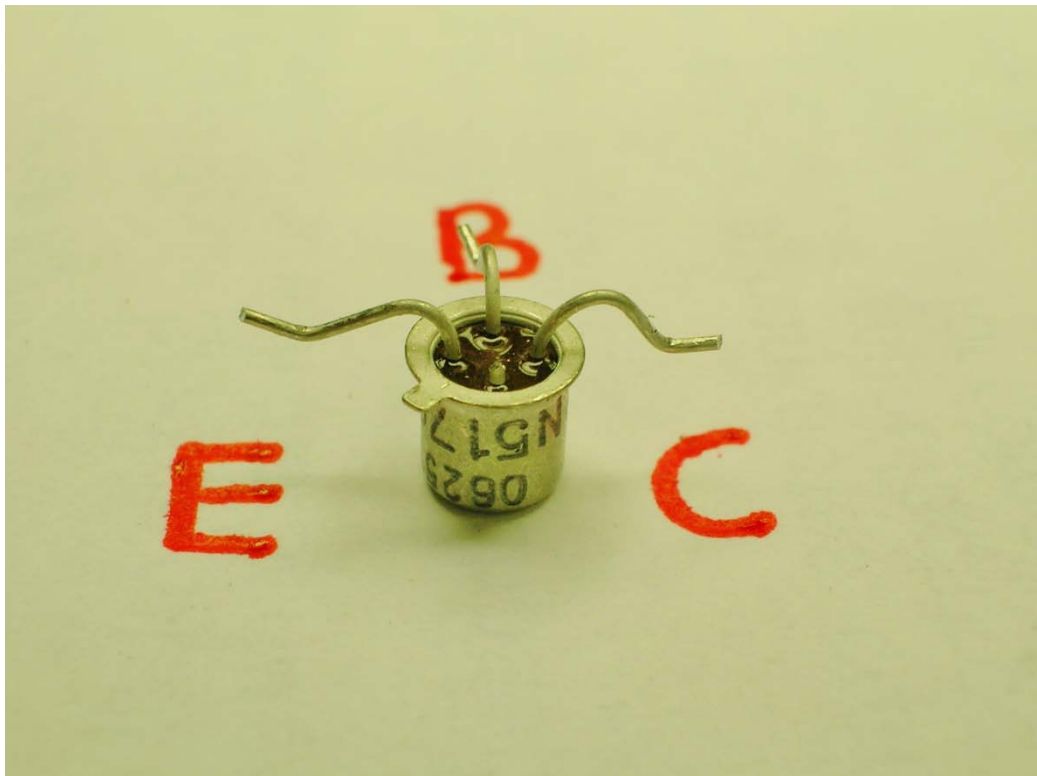

11. The winding on a 1/8" form and L1 pre-assembly for 222 MHz.



12. Tinning the bottom of C3 before assembly in 6-32 hole.

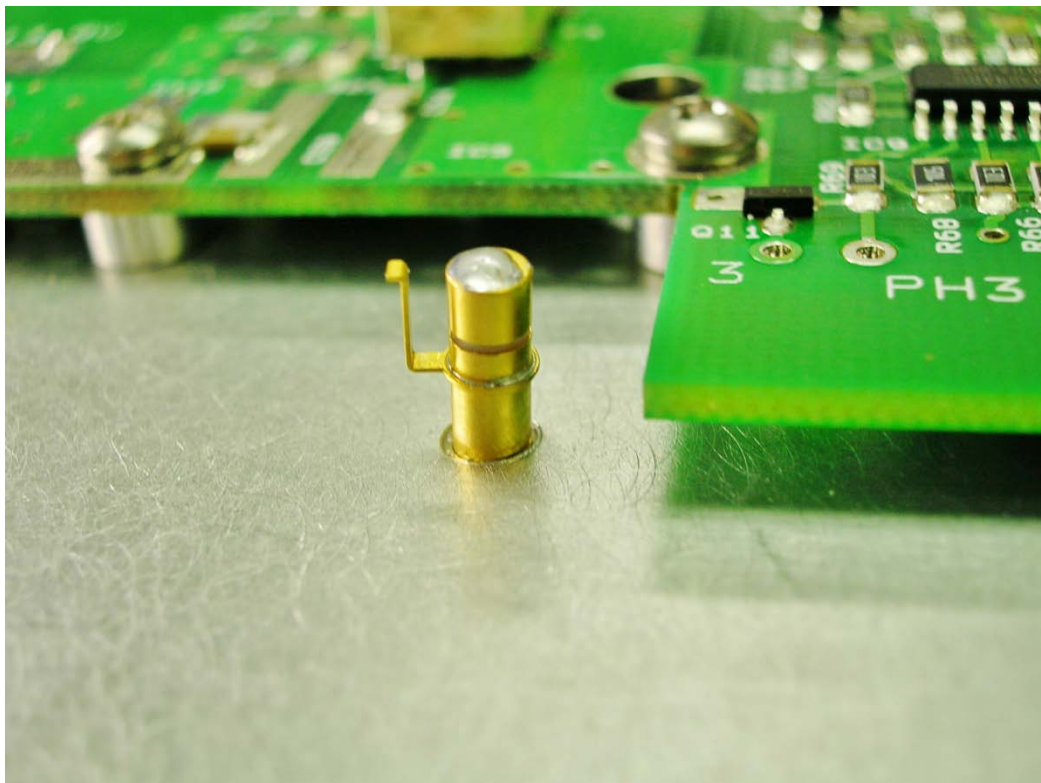

13. The correct LO and PTC assembly shown with 222 MHz L1.

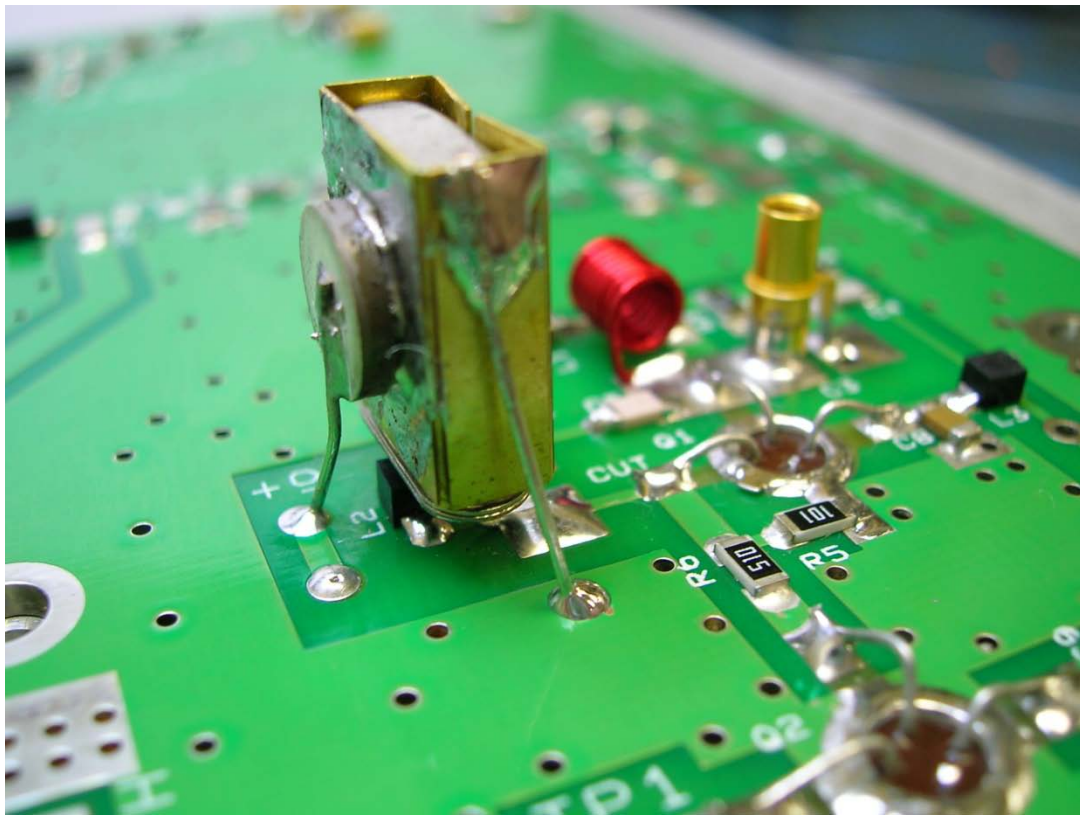

14. Low Pass LO filter for all but the 432 MHz transverter.

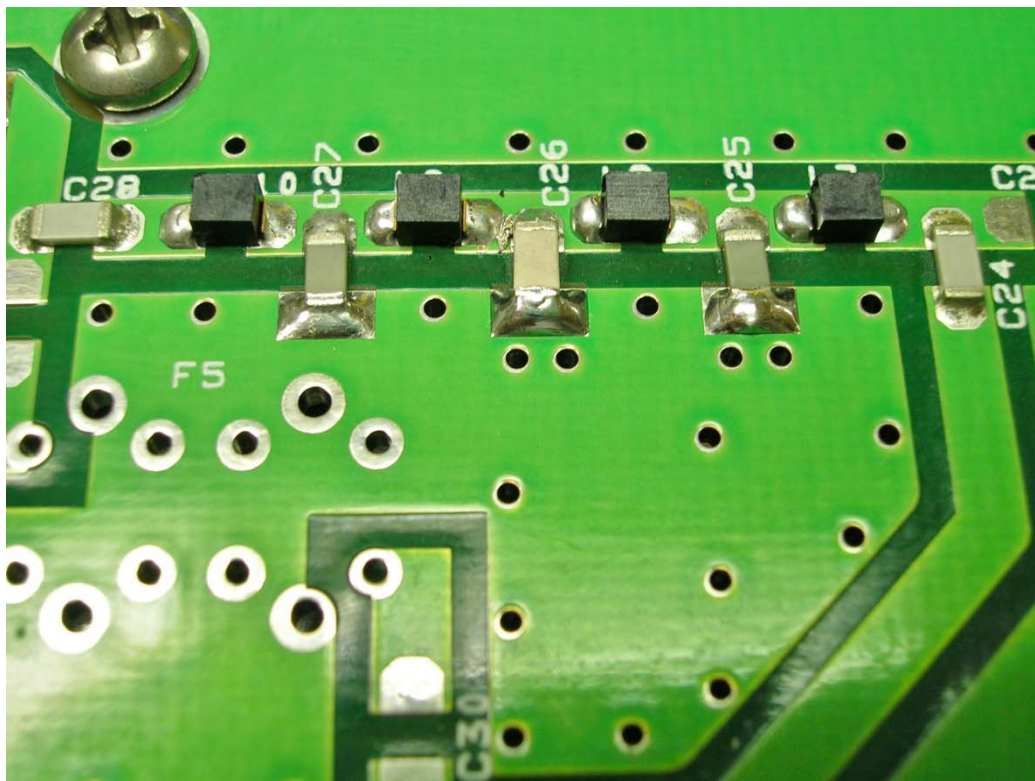

15. The correct mixer installation.

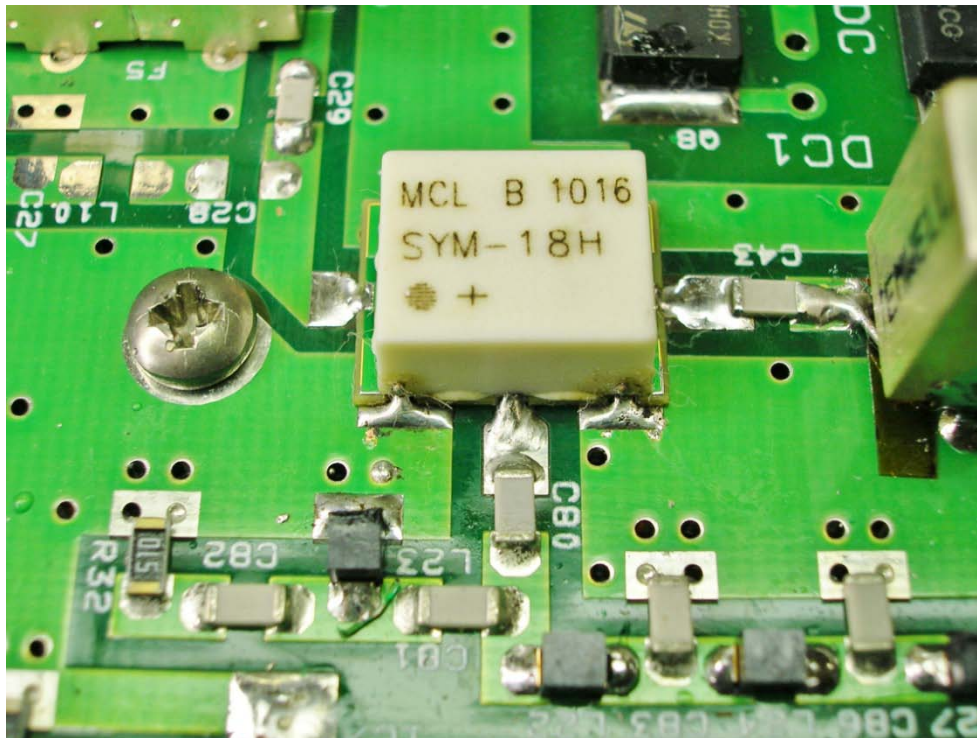

16. IF diplexer and PIN diode installation.

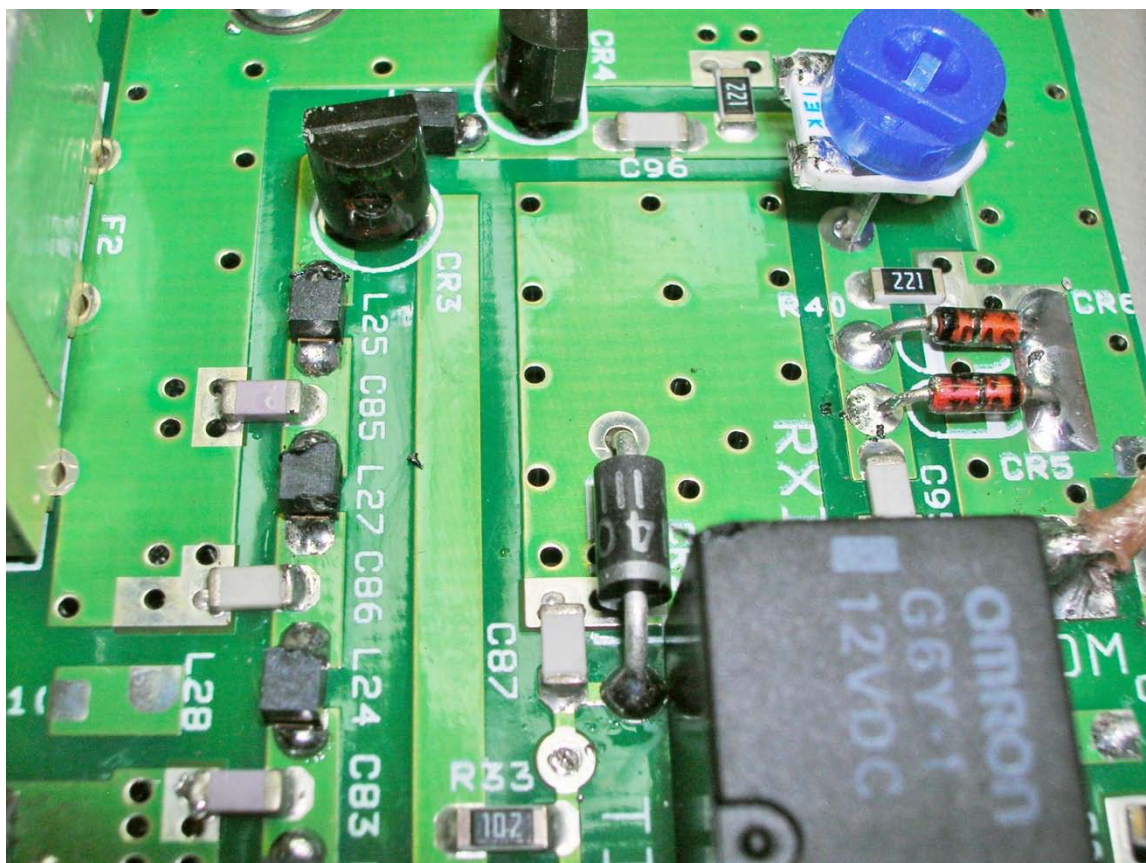

17. TX load installation.

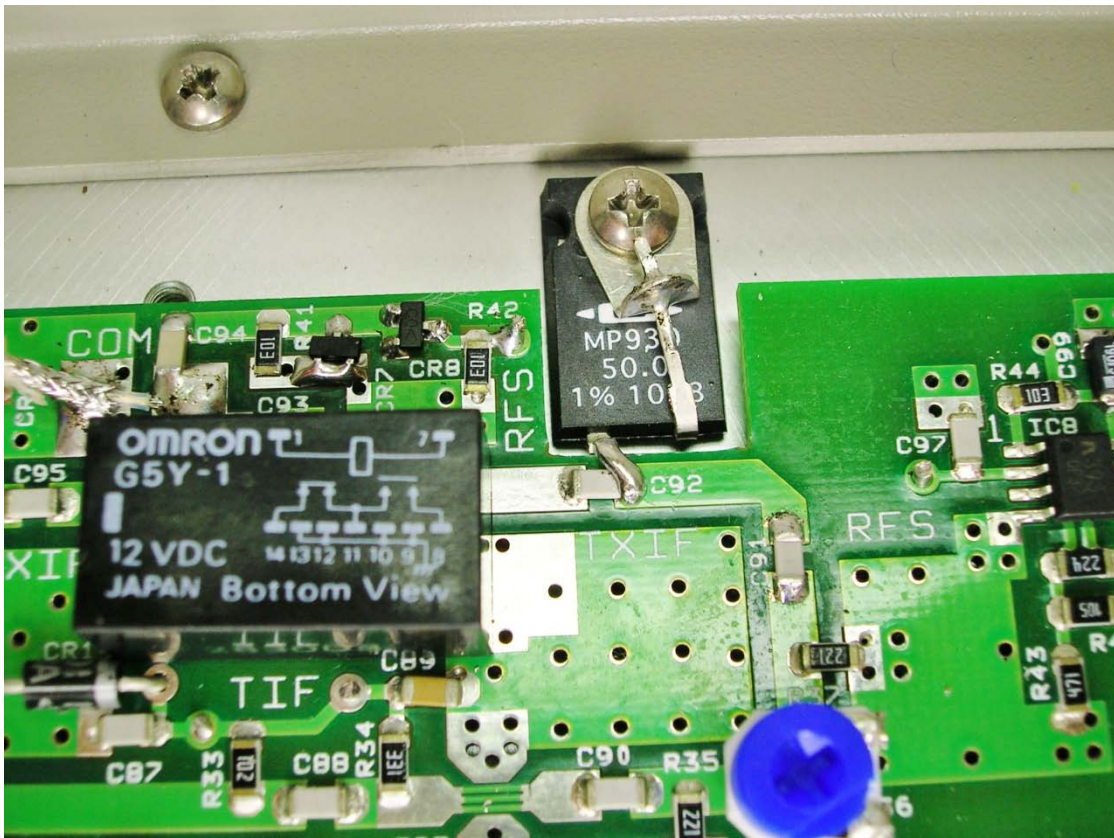

18. Negative Voltage generator installation on proto board.

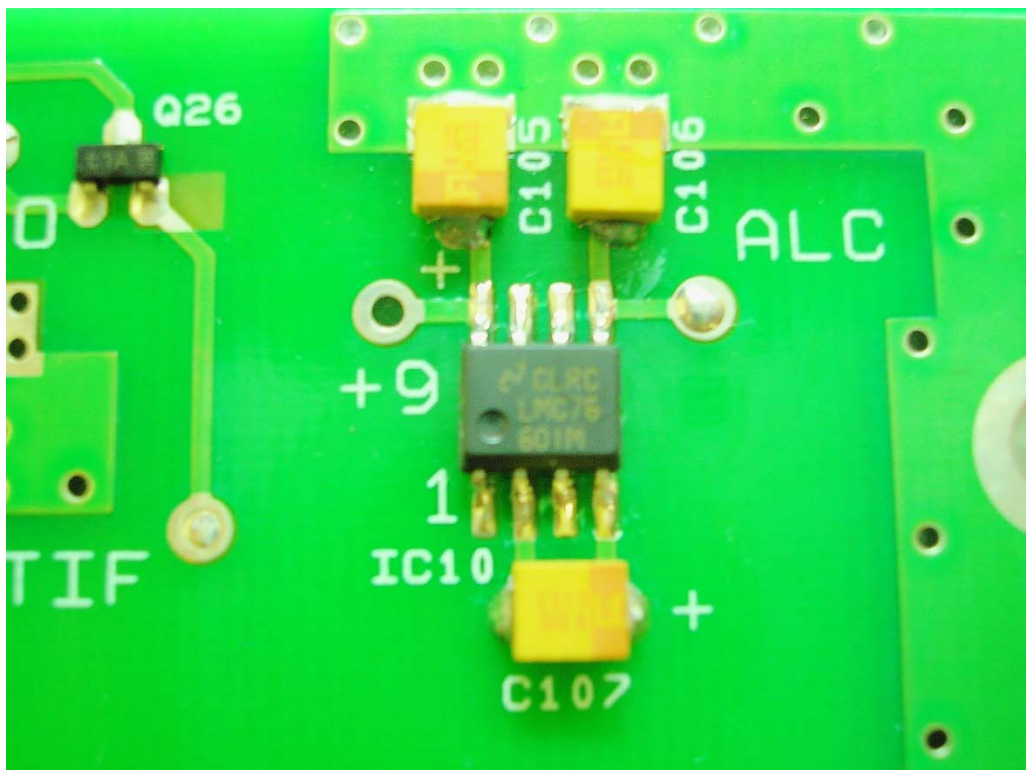

19. Sequencer and wiring.

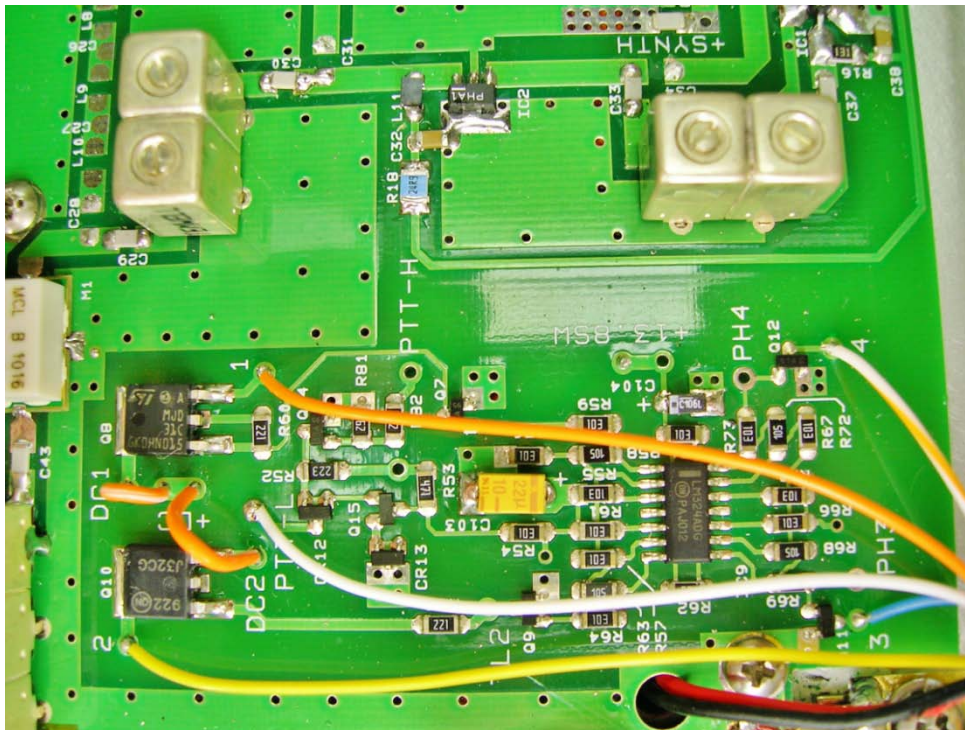

20. NTC install, Fan and other general wiring.

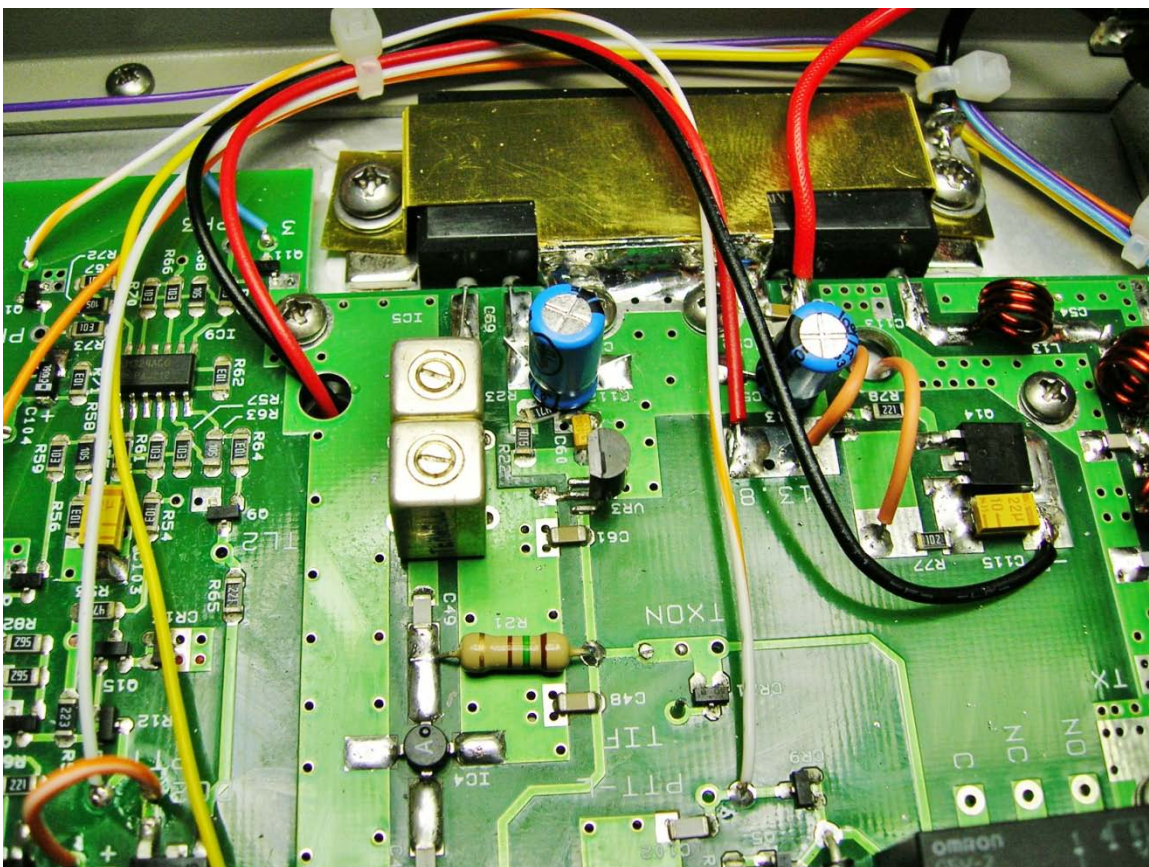

21. TX low pass filter, fan speed and power detect circuit.

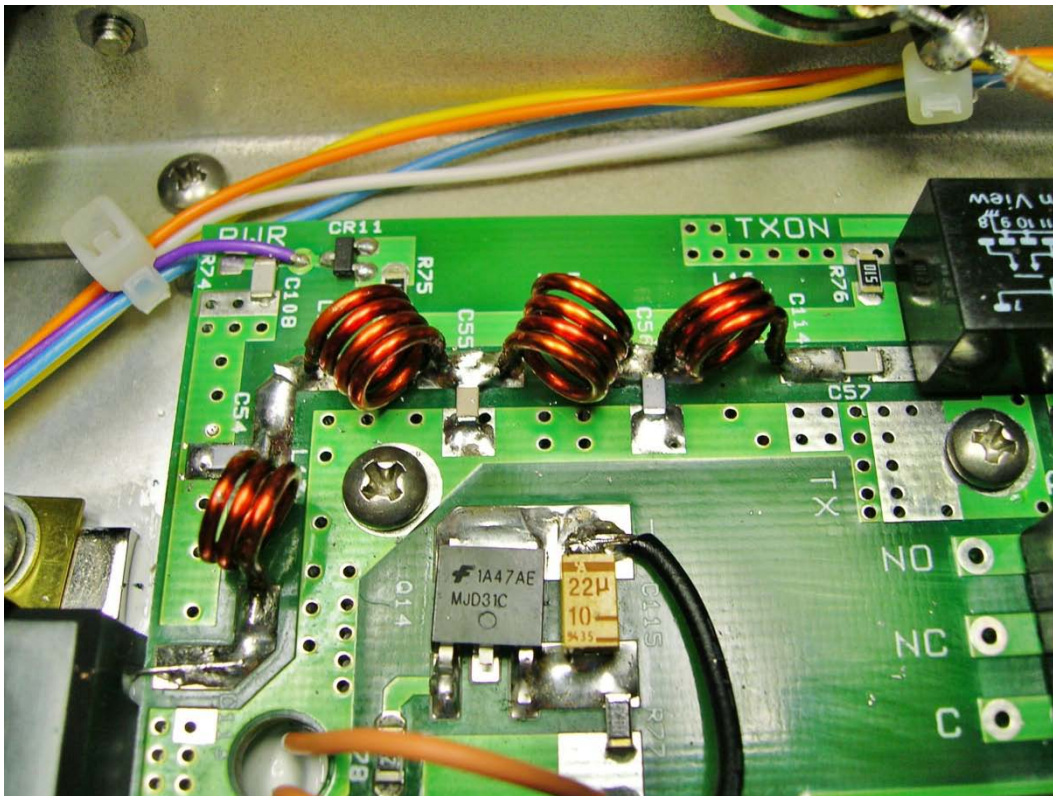

22. Generic LNA section assembly. L17 may be different.

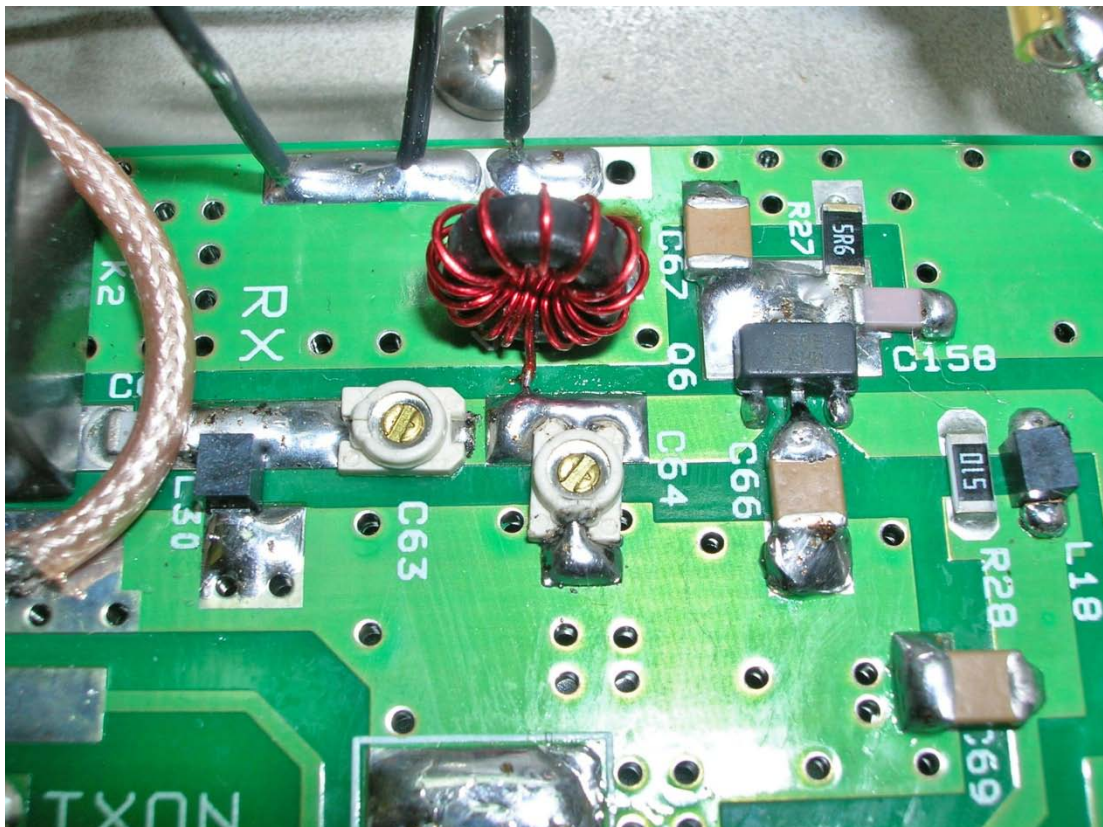

23. RX diplexer, gain stage and filter.

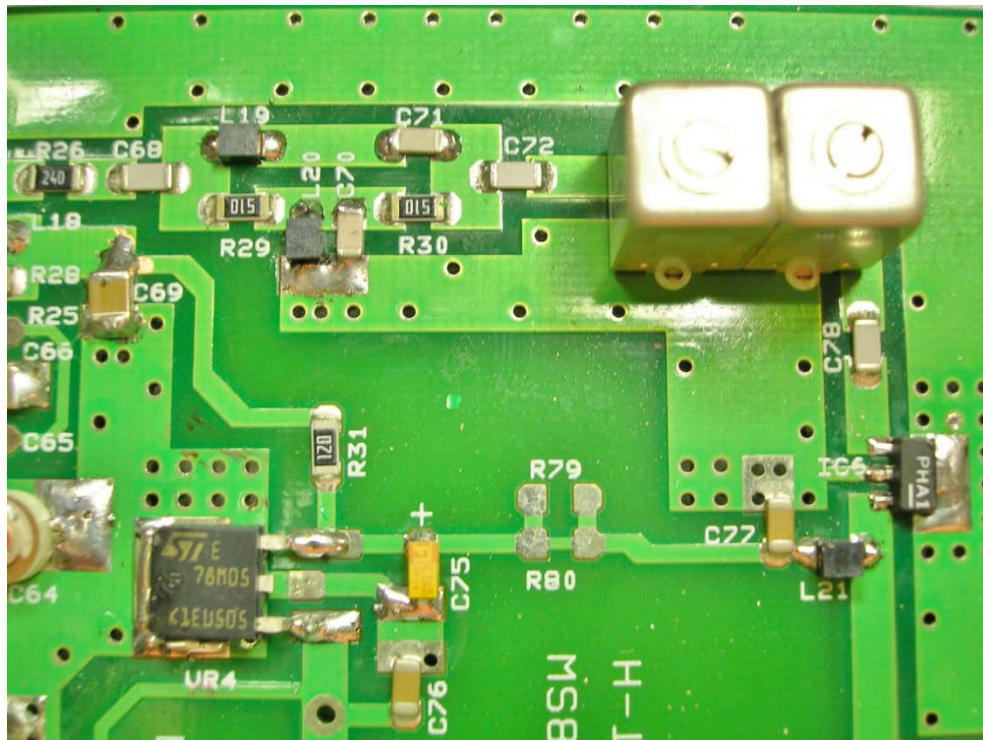

24. Power module shield install.

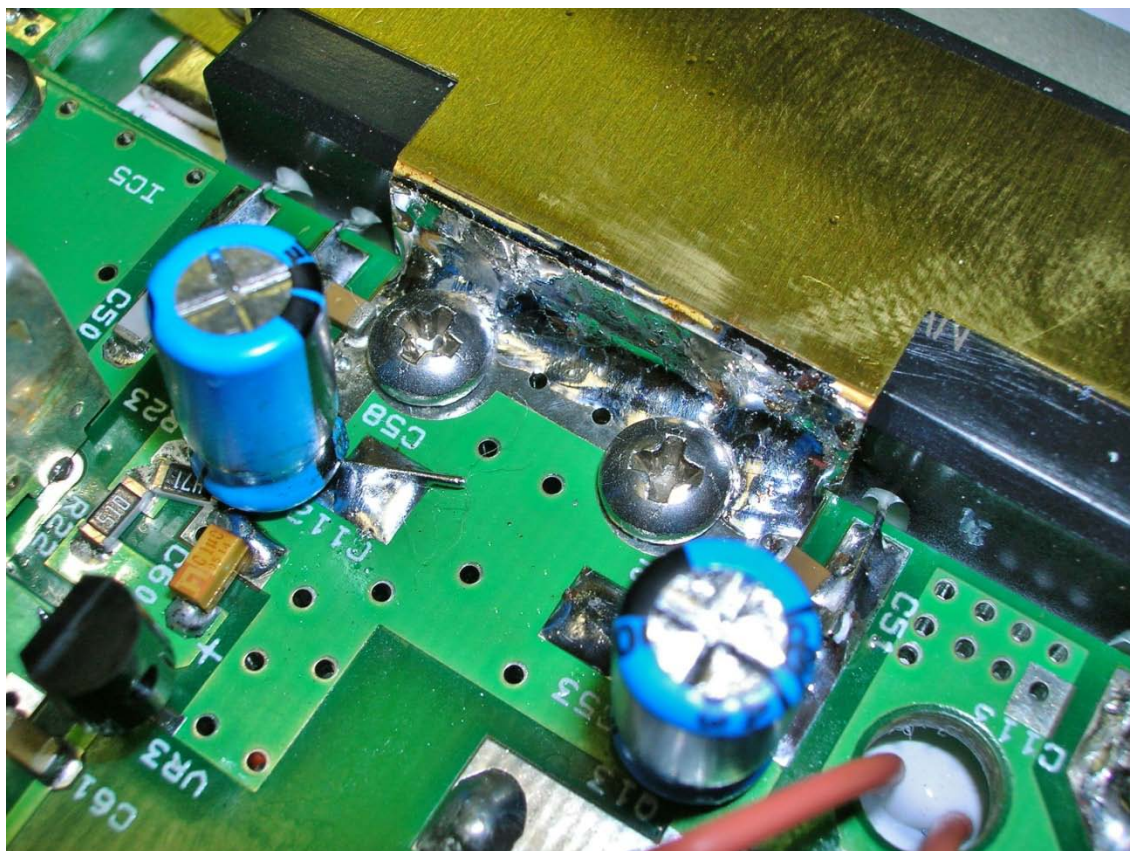

25. Connector panel wiring.



26. AUX, PTT and ANT connector wiring



27. Correct coax preparation

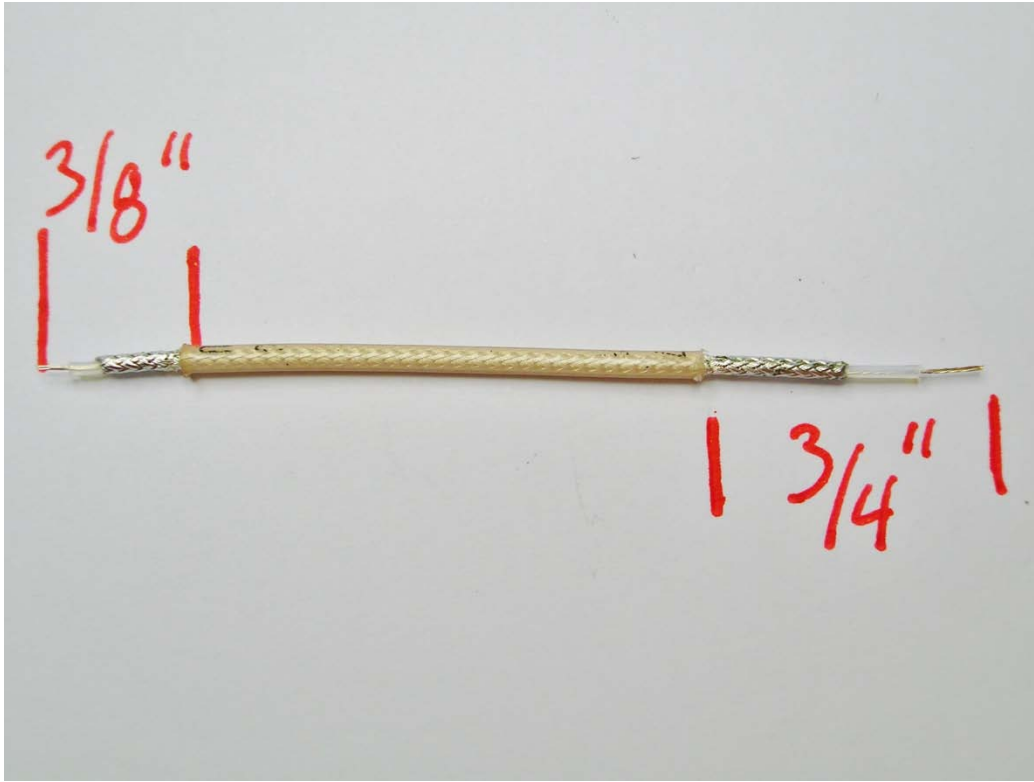

28. DC Connector wiring



29. Rear Panel

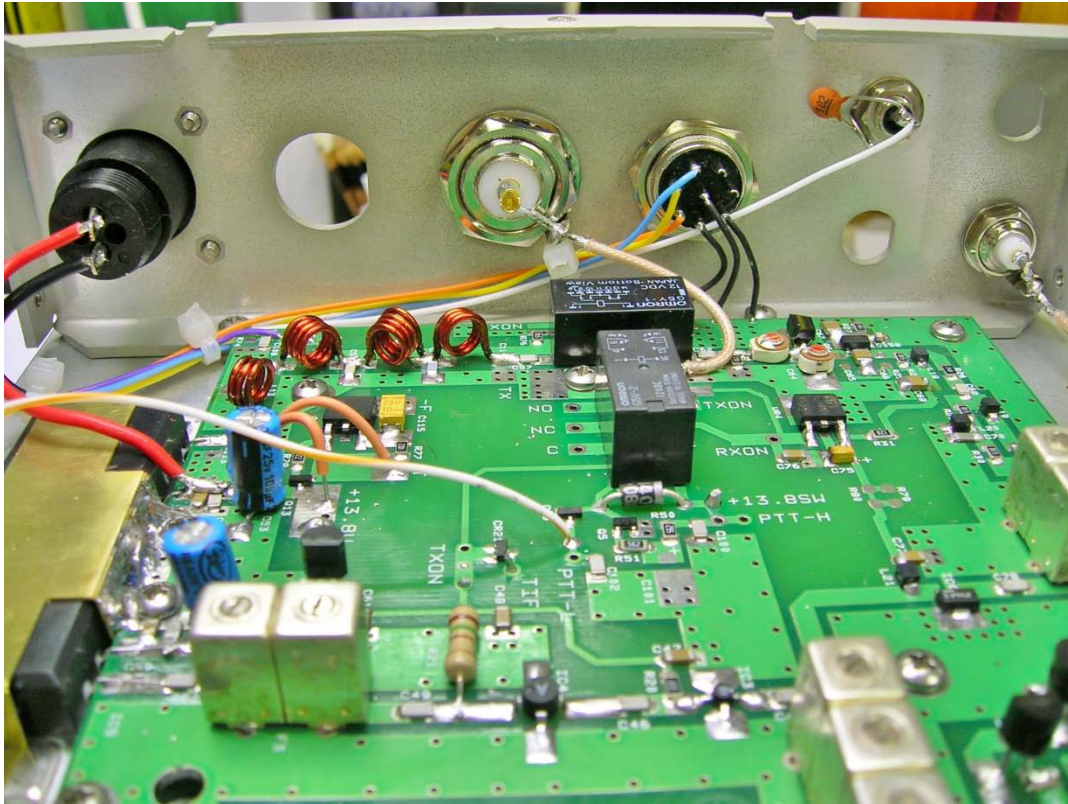

30. Coax and Ground wire install.

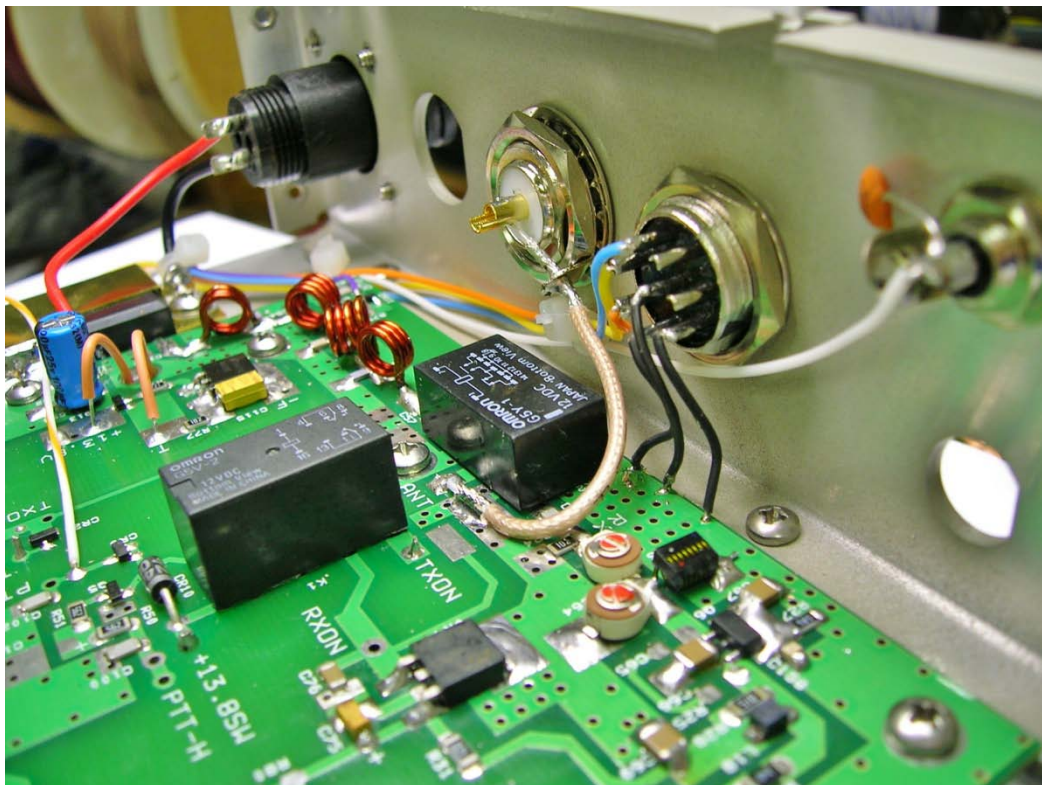

31. LO wiring and LO switch.

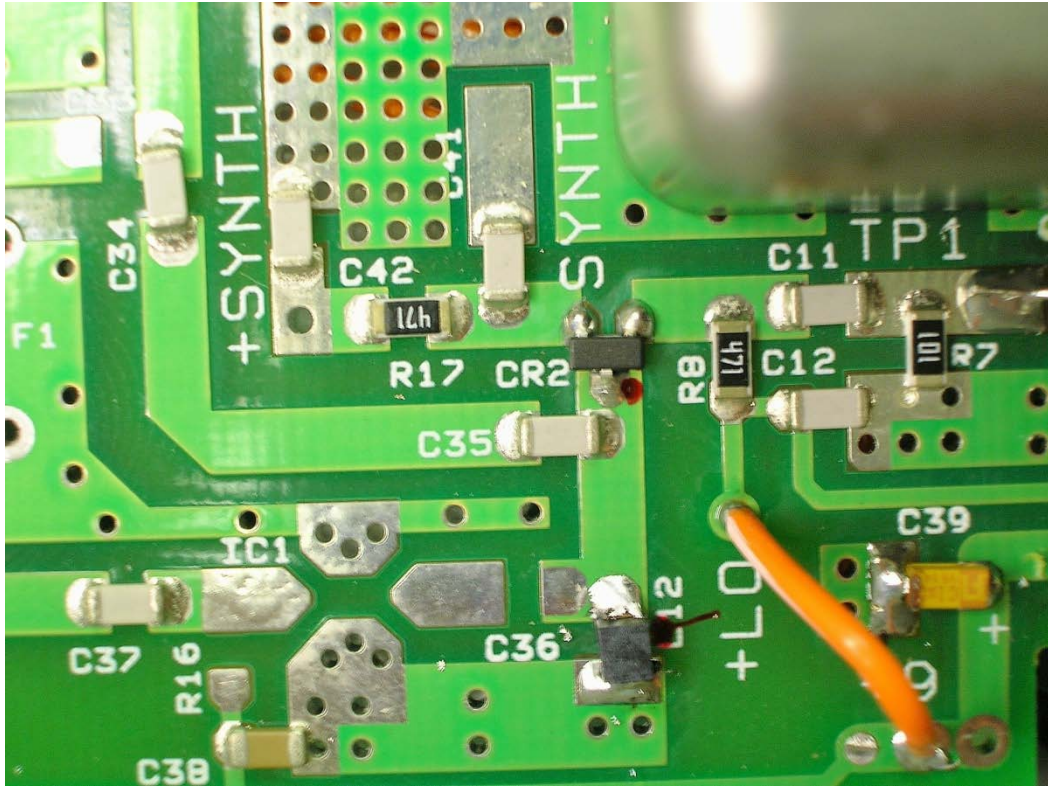

32. Power meter install, front panel wiring and LO shield install.

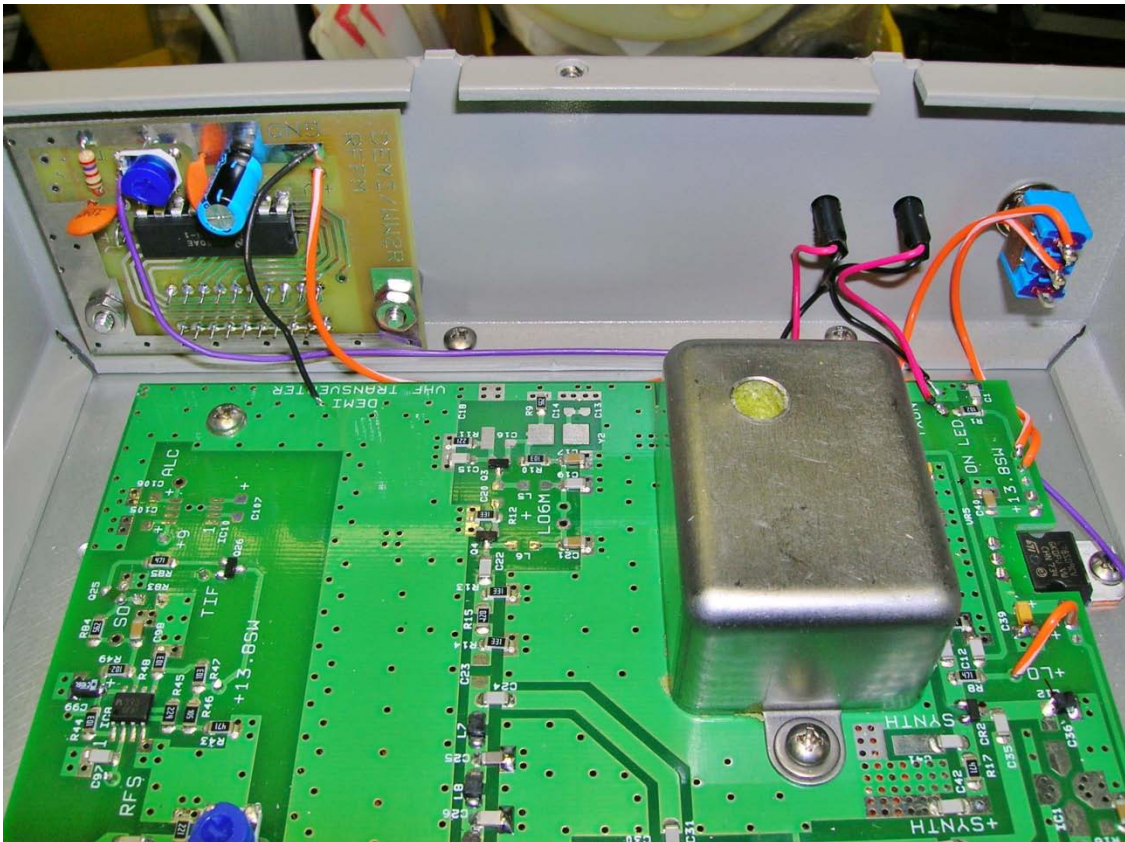

33. The inside view of completed transverter.

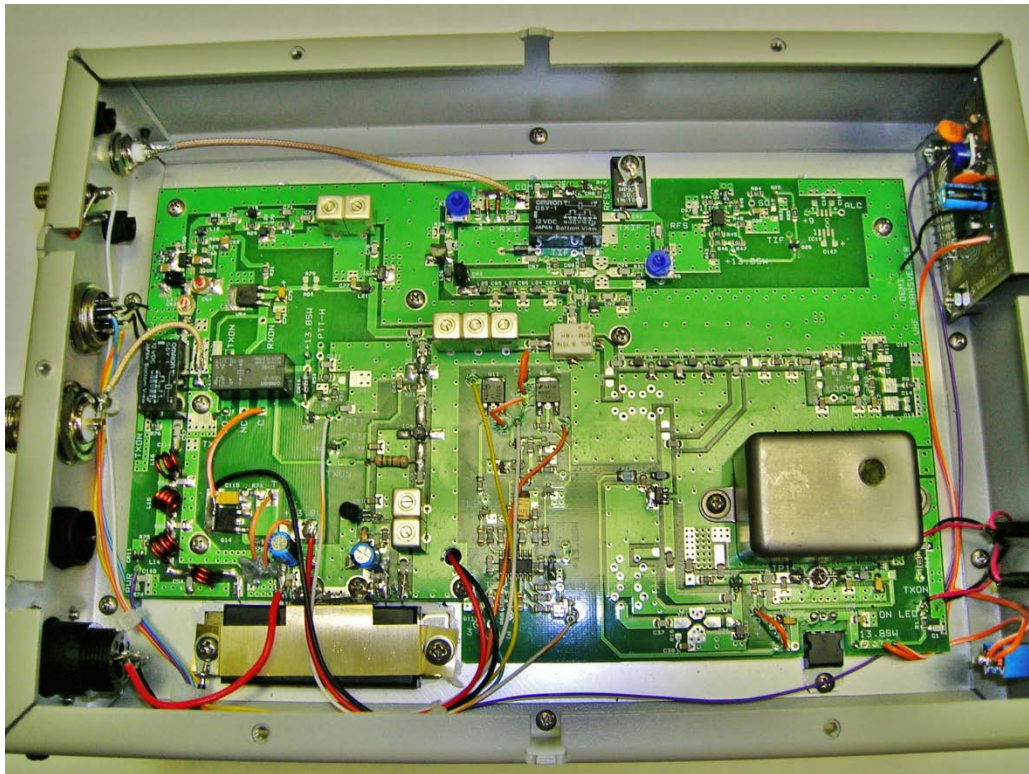

34. Rear view of transverter and fan install.



35. Front view of transverter.



36. The LO shield prep.

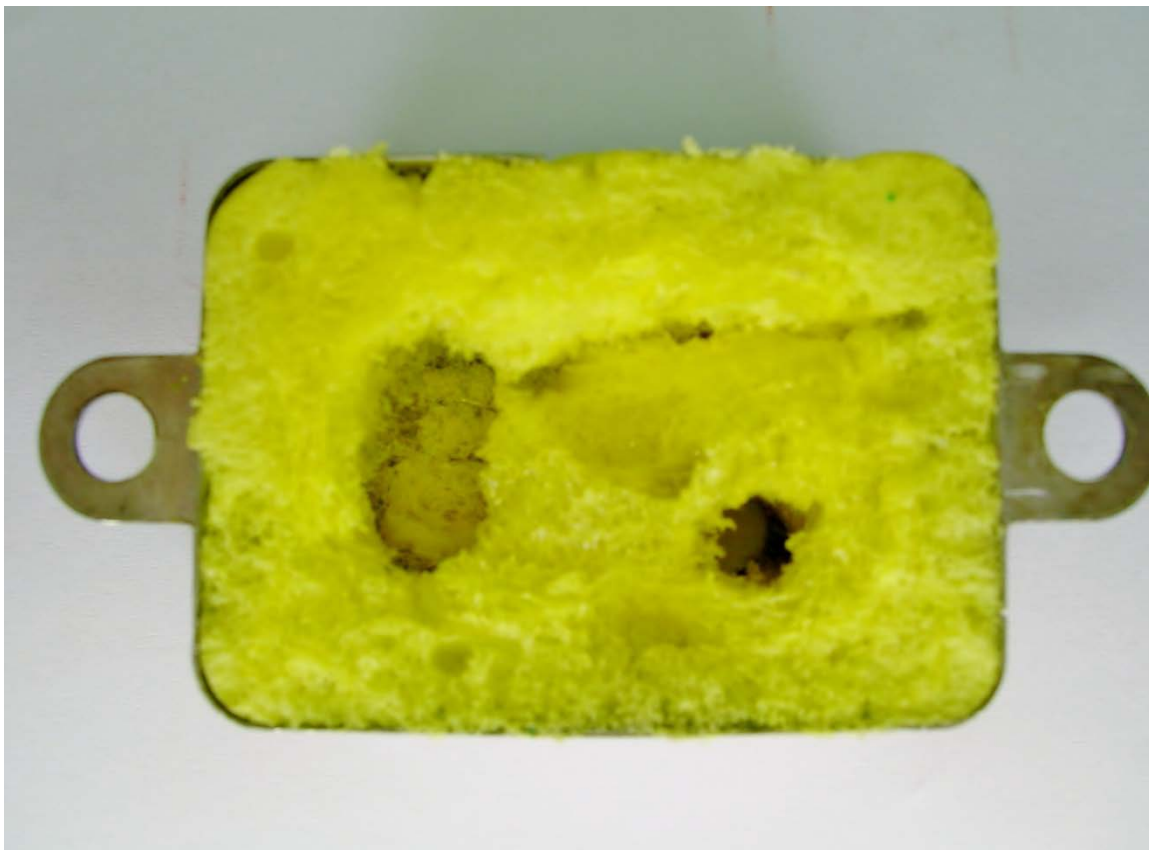

37. DC power connector assembly

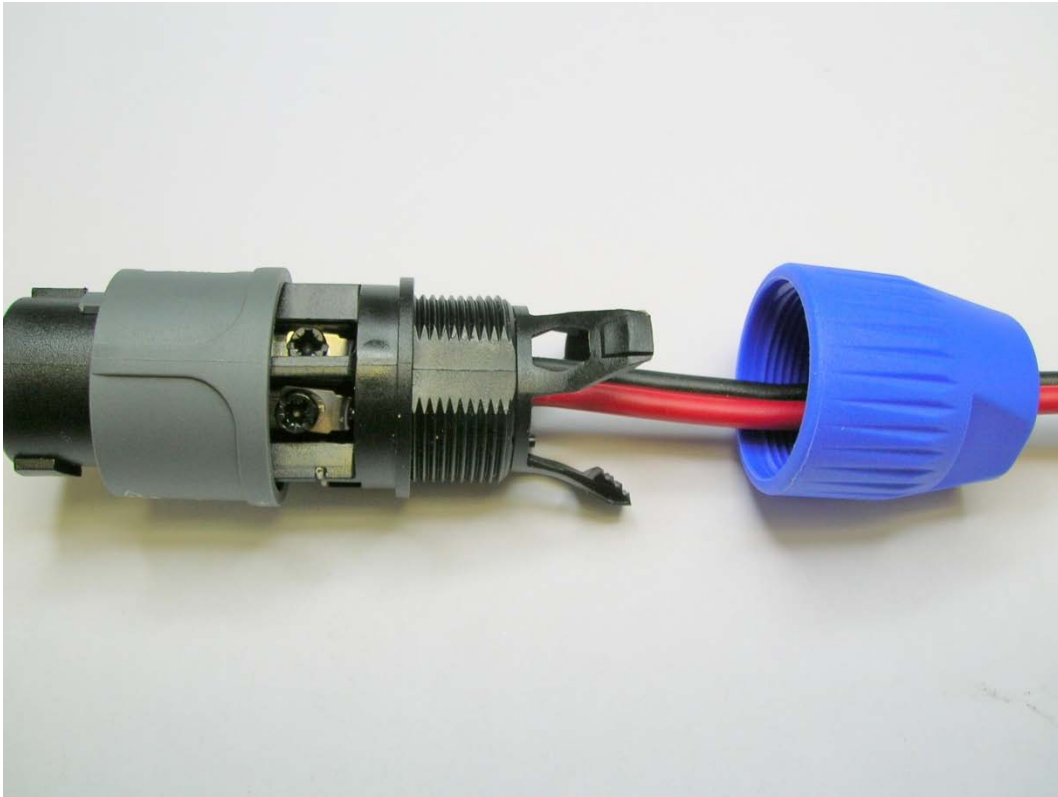

38. DC power connector

