

DEMI Part Number L70-28* SN _____
Transverter Configuration

Table with configuration options: Power Out Maximum, Noise Figure and Gain, DC Power Requirement, RF Option, IF Option, IF Drive Level Maximum, Keying Option, Options, and Aux Connector Pin #.

*Please Note: This unit is sold for exclusive use buy licensed individuals for armature radio purposes outside of the US borders. It is illegal to transmit with this device within any US possession for any purpose other than laboratory test into an approved dummy load.

Customer Specified Options: None See Below

Four horizontal lines for customer specifications.

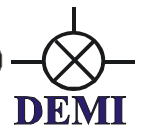
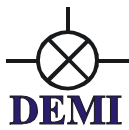

Configuration Overview: The DEMI VHF/UHF transverter line is designed to interface and operate with most High Frequency transceivers that are available on the market today. Since you choose to purchase an assembled unit, it has been configured by DEMI, per your specifications, to interface with your desired transceiver. This configuration may be changed or altered at any time if you desire to utilize a different transceiver or change you system configuration. Let's review your configuration and verify that your interface will be trouble free. Please refer to the front page.

DEMI Part Number Verification: All DEMI VHF/UHF transverters contain the operating frequency within the part number, i.e., 70-28HP is equated to 70 MHz is converted to 28 MHz. If you ordered a special frequency conversion, it will be listed here. Also, please understand that the conversion is simple math. If you desire to operate on 71.500 MHz. with your 70-28, it will require you to adjust you transceiver to 29.500 MHz.

Power Out Maximum: The part number will identify the transverter as either a high power (HP) or a standard power unit. The output power will be circled or marked **other** with a hand written level on the line. This level, 25W, 50W or other, is the **linear** output power level that should not be exceeded if linear operation is expected. The transverter may be capable of producing higher output power but is not recommended because of excessive heating that will interfere with its frequency stability while producing excessive "on the air" distortion products

Noise Figure and Gain: The noise figure and gain listed are nominal minimum requirements and most transverters exceed these specifications. In utilizing the latest PHEMPT technology, we have designed the complete receive section of the transverter with extra filtering, diplexing, and gain management in mind. There is also a RXIF gain control that is adjusted by the user to set the "S" meter level on the transceiver. External receive pre-amplification interfacing will be covered later in this document.

DC Power Requirement: The DC power requirement is listed and should be used as a guideline. The standard and High Power transverters do require different supply currents. Please include some "Buffer" in your power supply to eliminate voltage drop delivered to the transverter. Basically, do not utilize a 5-amp power supply for a 5-amp requirement transverter.

RF Option: The RF option is either a single port (Common RF) for both TX and RX or there will be two separate ports, (Split RF) one RX and one TX. With the standard level unit, there will be a PC board relay doing the Common RF switching. The HP unit will have a coaxial relay mounted to the connector panel of the transverter and will be an additional cost option. The standard level unit may be changed from Common to Split if the user desires. It will be covered in the manual. The HP transverter will require additional components to change. The TR relays are controlled by the Push-to-talk (PTT) circuit.

IF Option: The IF options are much like the RF option but in reverse. The transverter may be set up as Split IF (separate TXIF and RXIF in/out lines) or can be configured as a Common IF. There is on board relay that will switch the RX and TX to the correct direction and is controlled by the PTT circuit.

IF Drive Level Maximum: Depending on your transceiver or your specific IF drive requirements, the transverter will operate at its maximum linear output power with your specified maximum drive level. There is a TXIF gain control with 15-20 dB of range to allow the user to set a specific output power less than maximum. The overall drive level range is determined by different sets of

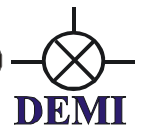
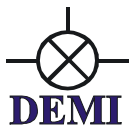

attenuators and gain stage levels if required. The useful operating "Range" will be between your specified maximum and approximately 20dB less.

Keying Option: The keying options are either PTT-L or PTT-H. PTT-L requires a connection to Ground to transmit. This is the most common keying option. PTT-H requires a voltage between 1.7 and 17VDC to transmit. This option can also be placed on the IF coax if desired. If you desired the sequencer to be utilized, the PTT connection will go directly to the sequencer to key it. It in turn will key the transverter on the last step of the sequence. Now doing so creates other problems if you choose to use a High IF drive level (above 200 mW). This is covered in the **Options:** section of this document.

Options: The **IF Drive Sense** option is installed with any Common IF drive level above 200 mW. This circuit is a protection circuit that will prevent excessive IF drive levels from damaging the RXIF circuitry and the Mixer. When utilizing a high- level IF drive transceiver, the IF drive is applied at the same time as the PTT is energized (unless your transceiver has some sort of delay circuit built in). If the transverters sequencer is utilized, the transverter will be keyed last in the sequence. This will result in the high level IF drive being applied to the transverter's RXIF section which could cause damage to the circuit and Mixer. The function of the IF drive sense circuit is to first detects the high- level drive, then enable the TXIF attenuator. This is done to protect the transverter's RXIF section and Mixer. It then holds and waits for the Transverter to "Catch up" in the sequence. This circuit will allow a user to key the sequencer circuit with the standard PTT circuit of a transceiver without having an issue or requiring external wiring or modifications to the PTT circuit.

This circuit will also protect the transverter in case the PTT circuit fails between the transverter and the transceiver. If the transverter is keyed directly with the PTT (sequencer is disabled) it will function normally.

The IF drive sense circuit should not be used to key the sequencer because it will produce long delays between transmit and receive or chop off the beginning of a transmission. If the transverter is configured with the IF drive sense enabled for any other purpose than protection, it will be discussed with you before delivery to assure its proper operation.

The **Negative Voltage** option is utilized by transceivers without transverter ports and ALC inputs to adjust the output power of the transceiver. If the transceiver has an ALC input, this connection can be made through the AUX connector and will be indicated.

The **Cooling Fan** will be installed on all HP units but is an **option** on the standard level transverters. It is designed to follow the temperature of the heat sink. As the temperature increases the fan speed will increase to provide the additional cooling and frequency stability.

If other customer special specified options were requested, they will be indicated at the bottom of the front page.

Aux Connector Pin # The AUX connector is just that. All other I/O's of the transverter are found in this connector. All transverters will have the sequencer pre-wired and will be indicated how it is configured. There are extra pins in the connector and may be specified by the user for various IN/OUT configurations. They will be indicated as such.

Customer Specified Options: All other customer specified options will be listed and identified. If for the reason of installing, other options were eliminated, it will be specified and detailed with any special instructions required for correct operation.

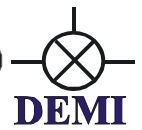

Installation

Theory of Operation: The basic principle of this VHF/UHF transverter is to convert a desired band of operation to the 10 meter band allowing the use of a HF transceiver. Following the recommendations of the HF transceiver’s operation manual for transverter use is the most important aspect of correct transverter operation. If configured correctly, the transverter will convert both transmit and receive signals to a new band of operation and seem “invisible” to your HF transceivers operation. In simple terms, the transverter will not improve the performance of your HF transceiver but will not cause any degradation of performance in any way.

Interfacing and Operation: The interfacing starts with a complete understanding of your HF transceiver and manual. The manual should cover the setup for transverter operation and the connections to be made to the HF transceiver. Some transceivers are simple and some are complex. Some transceivers may have more than one correct way of interfacing. Hopefully, you have decided on how this transverter is to be interfaced at the time of order so we were able to configure the transverter to fit your requirements. If you find that this transverter is not configured correctly, refer to the **Option Setup** section of this manual concerning changing of configuration or contact us directly. All configurations are user changeable and detailed instructions are included.

Start the interfacing with good quality 50 ohm cables for the IF (28 MHz.) connections. These connections are low level (25 watts or less) and are BNC connectors on the transverter. Your HF transceiver may have various other types of connections. We find that simple RG-58 type BNC cables work fine with or without adapters to your HF transceiver. All transverters will require a PTT (to ground or positive voltage on TX) to enable the transmit mode of the transverter. The PTT input to the transverter is a RCA connector. This cable does not need to be shielded, but extra protection in a QRO station is a good idea! Most transverters have RCA connectors for PTT outputs but others have various connections. Be sure to have whatever cable that is required ready to go. The DC power cable is supplied with the transverter and needs to be prepped on the power supply end. The AUX connector will contain all sequencer connections and any other special customer requirements. The matching connector to the AUX connector is supplied and should be wired before interfacing unless further testing of your system is required. Review the pictorial of the rear panel and/or the rear panel of the transverter.

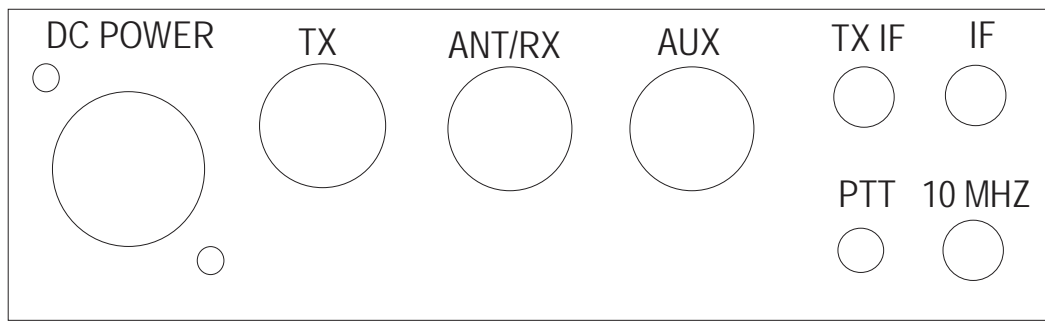

Rear Panel view

Connect your transceiver to the transverter: Interfacing the transverter to the transceiver is easy. After reviewing the front-page configuration and verifying that it is configured correctly for your purpose, begin cabling. **An Important note:** It is recommended that during the initial setup of the transverter, that it is not connected to your complete system with a HPA or mast mount LNA. All aspects of the transverter’s performance should be tested before a complete installation is made. Drive levels need to be established and proper switching needs to be verified before complete integration.

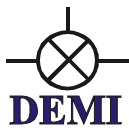

1. Connect the DC POWER to the transverter. It uses an AMP type connector and is supplied with the matching cable. 13.8 volts is optimum but the transverter will operate normally from 11 to 15 volts. Verify the DC power consumption of the transverter and use a power supply with some headroom. Cycle the power switch on the transverter and verify the Green light. Leave the transverter powered off.
2. If you ordered the **Negative voltage** option to use with your transceiver's ALC circuit, refer to the **Option Setup** section in this manual for details on set up and test your transceiver for transverter operation.
3. Connect the IF cable/cables. The transverter may have a common IF port or two separate ports, TXIF and RXIF for the IF connections. The connector labeled "IF" is either the common port or the RXIF port depending on your requested configuration. Verify on the front sheet. The IF cable is either connected to a transverter port connector or the main Antenna connection of you transceiver. Refer to your manual.
4. Connect the "Push-to-Talk" line out of your transceiver to the transverter. It is a RCA connector labeled PTT on the transverter. Refer to the configuration sheet for the type of keying required.
5. If separate TX and RX ports were ordered, the internal transfer relay option has not been assembled. The separate ports are labeled TX and ANT/RX. If you have requested a common RF connection, the "ANT/RX" port has both TX and RX functions. Connect your antenna system or dummy load with a power meter to the appropriate RF connector on the transverter.
6. On the bottom of the transverter, verify the TXIF and RXIF gain controls in the transverter. Turn the RXIF control fully clockwise and the TXIF control counter-clockwise. This is maximum attenuation on Transmit and minimum attenuation on Receive.
7. Power your transceiver "ON". If you transceiver cycles during power up, it may key the transverter. This is indicated by the Red "XMIT" light and the sound of relays cycling. Verify that the HF transceiver is in "receive" and that the red XMIT light is off on the transverter. If not, shut off your HF transceiver and check the PTT connection with the IF cables disconnected from the transverter. If both transceiver and transverter are in their receive modes, tune the transceiver to a frequency between 28.100 and 28.250 Mhz. unless you ordered a "none standard frequency" transverter and then depending on the conversion frequency, select an IF frequency in the middle of you operation range.
8. Observe the noise level in the transceiver on the "S" meter and by ear. If it is too high, adjust the RXIF gain control in the transverter counter-clockwise until a slight noise increase is heard in the transceiver or just a slight movement in the "S" meter is detected. Power the transverter on and off to verify the change. The RXIF gain may be increased beyond this point, but it will start to degrade the dynamic range of your transceiver. It is all user preference. If you plan to use an external or mast mount LNA, this level will need to be re-adjusted. Find a signal on the band or use a signal generator to determine correct frequency, or minimum signal level.
9. It is now recommended to test the transverter's transmit section in the CW mode because most transceivers have carrier level or power level controls in this mode only. If your transceiver requires the use of the **"negative voltage option"** you may not have a power adjustment ability on your transceiver. Do not use full or semi break-in if possible. Do not use FM, SSB or AM because it may not be possible to obtain maximum output power with a transceiver in these modes. Set the carrier/output power control to minimum or "0" output power (if you can). Place the transceiver into transmit. If the PTT circuit is connected correctly, the red "XMIT" light on the transverter will switch on. While observing the built in relative power meter or an inline RF power meter, slowly increase the carrier control (with key down) or increase the power output control to the maximum desirable IF drive level obtainable by your transceiver (maximum of 25 watts!) If this level is not what is indicated on the front page of this document, do not exceed

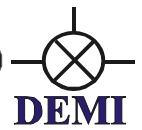
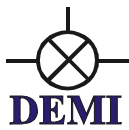

that level. If you find that the transverter is not set-up for your transceiver's range, go to the **Option Setup** section and re-configure the transverter before further testing.

If the transverter is configured correctly for your transceiver, minimal power may be detected on the power meter. With the transceiver's drive level at maximum specified for the transverter, slowly adjust the TXIF control in the transverter in a clockwise direction while observing the power meter. Set it to any desired level between 0 and the maximum specified output power. The relative power meter is set to show 9 bars lit for the specified maximum linear output power. This may vary with a bad VSWR but will be true into a 50 ohm dummy load. Switch the transceiver to USB and make a transmission. The power output and current drain should correlate to your speech pattern.

10. You may re-adjust both RXIF and TXIF again if desired. The receive amplifier section and local oscillator frequency should not need to be adjusted but you may if you wish. Do not adjust any of the helical filters unless you have access to a spectrum analyzer at the minimum.
11. The AUX connector mate may be now wired for your installation. If you require something other than what is indicated on the front page, please see the **Option Setup** section for further details. Also read further about interface and testing a mast mounted LNA in that section.

Basically, the transverter is ready to use and may be integrated into your system. Connect as you wish to use it in your system. If your system requires the use of the sequencer or you desire to implement it please refer to the **Option Setup** section of this manual.

General Operation: General operation of the transverter, if everything is adjusted correctly, should be transparent to the transceiver and the user. Except for the frequency read out, (if your transceiver doesn't allow its display to be adjusted for transverter operation) it will be like operating on 10 Meters. All of the functions of the transceiver (filtering, DSP, split band operation, dual VFO) will be transposed to the frequency band of the transverter.

Some cautions should be taken when operating CW or VOX. Operating the transverter in a "Full Break-in" mode is not recommended. Because of the mechanical relays in the transverter, there will be too much delay to operate "Full Break-in" effectively. AND—the relays would be abused if "Full break-in" is enabled. It is best to operate in "semi break-in" and adjust the delay of the PTT on your transceiver to match your comfortable CW operating speed in a way that the delay will hold the PTT until your transmission is complete. Since all transverters will be delivered with the sequencer enabled, this delay will need to be longer to allow all components within the system (Power amplifier, LNA, relays,) to complete their transition if utilized. If the stock transceiver is to be used alone, the transceiver PTT signal may be connected directly to the transverter's PTT input if the sequencer is bypassed. This will shorten up the delay but will not allow "full break-in" without relay chatter. See the **Sequencer Operation** in the **Option Setup** section of this document.

The transverter will experience frequency drift through aging. The frequency of the transverter's local oscillator has been "Netted" on our test bench at its normal operating temperature after a 24 hr burn-in. This will minimize its frequency shift from ageing but may need to be re-adjusted after prolonged operation. This is because of the physical nature of crystal ageing. As the hours of operation time increase, this "Zero Offset" frequency will be less and less and will not require adjustment to "Net" the frequency.

As for frequency drift during operation, great care has been taken to minimize it. The oscillator section of the transverter board is "ovenized" and the speed of the cooling fan on the heat sink is controlled by the actual heat sink temperature. The problem still arises from the internal air temperature of the transverter and the heat conduction of the heat sink to the oscillator section of the transverter board. Frequency drift is slight for SSB and CW operation but careful understanding

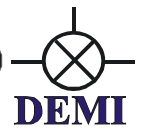

of the drift is important for digital mode operation. Our testing was done with 30 second transmit and receive times at the transverter's full rated output power. This has shown that the worst case most extreme drift will occur during the first few transmissions while the transverter reaches its stable operating temperature. If the room temperature is less than 75 degrees F (approximately 25 degrees C) the fan may not be running. The first transmissions may cause the Fan to cycle and if the heat sink temp rises, it will remain running slow. This first cycle will cause the largest frequency shift of about 10 Hz. The next 3-4 transmissions will stabilize the frequency drift after moving no more than 25 Hz. After a total of 5 transmissions, the frequency drift will be 1 Hz or less if all conditions remain the same during 30-second cycles of transmit and receive. Of course this may be better or worse depending on the transmit power, duty cycle, and luck of the draw on the tolerance of the components used in the assembly of your transverter. An operation recommendation would be to start your digital sked a few minutes early and you will achieve frequency stability at the actual start time of the sked.

Removal of the fan from the 25-watt transverter will allow the transverter to drift as much as 150 Hz over a ½ hr. schedule. This may be acceptable for SSB and CW operation but we have found the ambient fan noise of the transverter to be un-noticeable. The removal of the fan on the 50-watt transverters will allow the transverter to overheat and damage the output power module. Because of the heat sink structure of the High power transverter, the ambient noise of the cooling fan is greater but still not annoying in our opinion.

Option Setup:

Common or Split IF Option: The IF configuration may be change at any time according to the type of transceiver you are utilizing. Refer to the Component placement or schematic for clarification. The component designators are also screened on the circuit board.

K3 is the common IF relay. To split the IF lines into separate RXIF and TXIF, remove the IF coax from its position on the board (junction of C93 and C94) and re-attach the center conductor between C95 and K3. You may need to scrape a little solder resist from the pad before soldering. The shield may be now soldered where it was on the ground pad marked COM. The TXIF cable can be prepped and soldered to the pad between K3 and C92. Again scrape the solder resist if required. The shield can be soldered to the ground pad labeled TXIF. Install a BNC connector in the rear panel (TXIF) and attach the TXIF coax. Reverse the procedure if you want to change to or back to Common IF.

Please note that if you have a separate IF configuration, the IF drive sense option will no longer function. It is not necessary with the split IF. It is to protect the RX circuit and Mixer.

TXIF Drive Level Range: The TXIF drive level range can be changed at anytime to conform to your transceiver type. Basically, there are three configurations. For high IF drive levels, (250 mW-25 watts) the 50 Ohm load will be installed with a low value capacitor in the C91 position (10 pF or less for 25 watts). Mid level drives between 1mW and 250 mW will not have the load installed and will have a 1000 pF capacitor installed for C91. For the low drive levels (-20dBm to 0dBm or 1mW) IC7 will be installed. If you desire to change the drive level for whatever reason, just duplicate the info above. To install IC7, cut the ribs in the trace before installing. -10 to -6dBm inputs, use a MAR-3 for IC7. For -20dBm, use a MAR-6. Other MMIC's may be used but the bias resistor R33 may need to be changed. Adjust R36 to obtain desired level in all cases.

IMPORTANT NOTE: Do not assume that since your output power of the transverter is low that it is because you do not have enough IF drive. Please consult DEMI if you have problems obtaining full output power with your specified drive level.

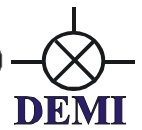
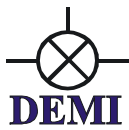

Common or Split RF connections: The common RF connection will be different depending on the output power model you have. If it is a **High Power** unit, the common relay will be installed on the rear panel of the transverter. Follow the cables from the relay to the circuit board. The relay may be removed and two separate type “N” or UHF connectors may be installed in the rear panel with coax to the C62 pad for RX and the C57 pad for TX. The relay may be left installed and used on the RX side. Just remove the TX side coax of the relay and install the connector of choice in the TX hole in the rear panel. Coax it as required.

If you have separate ports and wish to make them common, you can order a relay to be mounted inside of the transverter. This requires drilling holes in the rear panel. OR—DEMI can do it for you for a minimum charge.

BUT- a relay may be purchased to be mounted on the outside and it may be wired through the AUX connector. The relay’s DC power is found on the pad labeled TXON by CR1. This setup is also the most versatile.

The **Standard power** unit (25-Watt model) is similar. The common relay is K2 and is mounted on the circuit board. The common port is marked ANT on the board. The split connections are the same positions as the High power model. There is no need to remove the relay for the split connections. Depending on which way you are going, install/uninstall cables and connectors as required. And as in the high power unit, if you have separate ports, they may be combined with an external coaxial relay to provide versatility.

Negative Voltage Option: If you have ordered the negative voltage generator, an approximate -9VDC will be available on the AUX connector pin indicated on the front page. To set this up with your transceiver, connect the pin and ground to your transceiver’s ALC input. With both the transverter and Transceiver powered on, measure the output power of the transceiver on somewhere in the 28 Mhz. band to verify that the ALC circuit within your transceiver is operating correctly. With the negative voltage applied, there should be minimum power output (less than 1 watt or as low as a few mW’s depending on what type of transceiver it is) With the power meter still connected, if the transverter is powered off, the transceivers output power should come back to normal. Be careful if you are using a mW power meter!! If it all checks out, continue with Step 3 of the **Installation** section.

You may now connect the RF drive to the transverter and with the transverter switch on, you may continue to adjust the TXIF drive level in the transverter.

IMPORTANT NOTE: If you are using the ALC (negative voltage generator) circuit and you desire to use your transceiver for other than transverter use, operating it with the RF/IF cable connected without the ALC voltage running will damage the transverter. What is suggested is to place a coaxial relay (SPDT) between the transverter’s IF port and the Transceiver’s RF port. Wire the relay so that it directs the RF path to the Transverter when energized. Connect the +13VSW buss and ground to the relay through the AUX connector.

When the Transverter is switch on, the relay will direct the RF path of the transceiver to the transverter and the transverter will apply the negative voltage to the transceivers ALC port. Power the transverter off will simply switch the transceiver back to normal.

Sequencer: The sequencer configuration may be changed at anytime. If it was specified to be utilized, the transverter is connected to the 4th and last step of the sequencer. It is wired to the #4 point on the circuit board in the sequencer section. This is a “LOW” on transmit. The other connections are indicated on the front page and wired to the AUX connector. The reasoning is:

Step 1 +12VDC on RX for a preamp @ 500 mA maximum

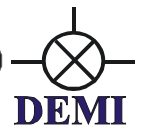
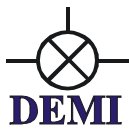

Step 2 +12VDC on TX for a TR relay (around the preamp) @ 500 mA maximum

Step 3 Ground on TX to key a power amplifier. Sinks 100 mA maximum

Optional Sequencer Connections:

Step 1 and 2. They can be connected to switch higher DC voltages. The DC voltage is applied to the DC1 and DC2 connections on the board (30VDC, 100 ma. maximum). Higher current at higher voltage, such as with multiple TR relays, may be switched on step 2 if the circuit is re-wired. The yellow wire in Via #2 near Q10 is removed and replaced with a connection to ground. The yellow wire is then placed in the DC2 connection. This will now pull any relay up to 500 ma to ground.

Step 2 TL2 is a secondary connection to the second step. It is a "LOW" on transmit. It can be used to drive a relay or key an amplifier but an external isolation device should be utilized. It will sink 100 mA maximum

Step 3 and Step 4. They have secondary outputs that are both "High" on transmit. They are labeled PH3 and PH4. These should be isolated from devices that require high currents and are intended to drive low current devices or Pass transistors or FETs. They will source 5mA.

For mast mount LNA operation with the basic transverter or with an external high power amplifier, all tests should be done without RF applied. Verify that the switching is completed in your desired sequence and gradually add in external components as verified. The last should be the transverter's RF applied. All testing can be done without coaxial cables connected. Connect the transverters IF or TXIF cable last.

The transverter's sequencer may be by-passed to eliminate switching time delays but is only recommended if the transverter is to be used without any other system components such as LNAs or power amplifiers. In this case the external PTT input of the transverter may be connected directly to the transverter's PTT input (see component placement document) near C100 (PTT-H) or C102 (PTT-L) bypassing the sequencer.

Relative Power Meter: The bar graph display is a relative power meter and is driven by the directional coupler and RF detector circuit found in the Low pass filter section of the board (CR11, R76,R75,C108) RF is detected and converted to DC voltage and conducted to the Bar graph display on the front panel. If you find that you operate the transverter at any other level than what we have calibrated it to (either 25 or 50 watts = 9 bars) you may change it by adjusting VR1 on the display board.

Other Adjustable Circuits: Other adjustments that may be made are the LO and RX front end. The Local Oscillator (LO) frequency may be adjusted with C18 Frequency may be monitored at the junction between C28 and M1. Adjust as desired! Frequency will shift over time so adjustment is expected.

The Receiver front end (the FET Circuit) should not need adjustment. It is aligned and tested into a 50-ohm test setup and optimized on a Noise figure meter. No, you can't screw it up by "Tweaking" it but unless you experience instabilities or outside interference, no adjustment should be necessary unless the FET is replaced.

All filters are aligned by the manufacture for input/output match and pass band ripple. Adjustments are not recommended or required. Its rare to have a failure of a passive component unless excessive "tweaking" has occurred.



DEM 70-28 COMPONENT LIST

Please note that depending on the RF and IF configuration, all components listed may or may not be utilized. Refer to the option set up section of this manual for details

Resistors (R) values are in Ohms and are chips unless otherwise specified. Some values are NR

R1 1K	R23 470	R39 220	R53 470	R67 10K
R2 – R8 NR	R26 24	R40 220	R54 10K	R68 1M
R9 5.6K	R27 5.6	R41 10K	R55 10K	R69 10K
R10 10K	R28 51	R42 10K	R56 10K	R70 10K
R11 220	R29 51	R43 470	R57 10K	R71 10K
R12 330	R30 51	R44 10K	R58 1M	R72 1M
R13 330	R31 12	R45 220K	R59 10K	R73 10K
R14 330	R32 51	R46 1M	R60 220	R75 100
R15 120	R33 1K	R47 10K	R61 10K	R76 51
R16 - R18 NR	R34 330	R48 10K	R62 10K	R77 1K
R19 470	R35 220	R49 1K	R63 1M	R78 220
R20 330	R36 1K POT	R50 5.6K	R64 10K	R81 5.6K
R21 150 ½ LEAD	R37 220	R51 5.6K	R65 220	R82 5.6K
R22 51	R38 1K POT	R52 22K	R66 10K	R84 5.6K

All capacitors (C) are in pF and are chip unless otherwise specified. "E" = Leaded Electrolytic, "T" = chip Tantalum

C1 1000	C43 1000	C66 0.1 μF 1210	C91 10 or 1000
C2 –C12 NR	C44 1000	C67 0.1 μF 1210	C92 1000
C13 24	C45 1000	C68 1000	C93 1000
C14 Test Option	C46 1000	C69 0.1 μF 1210	C94 10
C15 56	C47 0.1 μF	C70 75	C95 –C97 1000
C16 Test Option	C48 0.1 μF	C71 24	C98 0.1 μF
C17 0.1 μF	C49 1000	C72 1000	C99 4.7 μF T
C18 2-6pf Trimmer	C50 1000	C75 4.7 μF T	C100 1000
C19 1000	C51 0.1 μF	C76 0.1 μF	C102 1000
C20 24	C52 100	C77 0.1 μF	C103 22 μF T
C21 0.1 μF	C53 100 μF E	C78 1000	C104 4.7 μF T
C22 1000	C54 75	C79 1000	C105 4.7 μF T (opt)
C23 1000	C55 75	C80 1000	C106 4.7 μF T (opt)
C24 Remove	C56 75	C81 56	C107 4.7 μF T (opt)
C25 100	C57 1000	C82 150	C108 1000
C26 120	C58 100	C83 150	C111 3
C27 100	C59 0.1 μF	C85 150	C112 100 μF E
C28 1000	C60 4.70 μF T	C86 56	C113 43
C29 - C38 NR	C61 0.1 μF	C87 1000	C114 43
C39 4.7 μF T	C62 1000	C88 1000	C115 10 μFT
C40 0.1 μF	C63 2-10pF Trimmer	C89 0.1 μF	C158 100
C41,C42 NR	C64 2-6pF Trimmer	C90 1000	

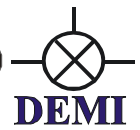

All inductors (L) are in μ H and 1008 chip unless otherwise specified. "PW"=pre-wound
 "HW"=hand-wound using enamel wire

L1-L4 NR	L13 6Turns #24 T37-12 HW	L22 330
L5 1.0 μ H	L14 7Turns #24 T37-12 HW	L23 150
L6 1.0 μ H	L15 7Turns #24 T37-12 HW	L24 220
L7 150	L16 6 Turns #24 T37-12 HW	L25 150
L8 330	L17 9Turns #28 T25-10 HW	L26 330
L9 330	L18 330	L27 330
L10 150	L19 220	L30 1.0 μ H
L11 – L12 NR	L20 56	1.0 μ H molded choke
	L21 1.0 μ H	

Solid State, Relays and Filter Components

CR1 1N4000 type	IC1 ,IC2 NR	Q7 PMBT3904
CR2 NR	IC3 MAR3	Q8 MJD31
CR3 MPN3404	IC4 MAV11	Q9 PMBT3904
CR4 MPN3404	IC5 RA30H0608M	Q10 MJD32
CR5 1N914 or 4148	IC6 PHA-1	Q11 PMBT3904
CR6 1N914 or 4148	IC7 MAR6 (option)	Q12 PMBT3904
CR7 HP2800 SMD	IC8 LM393	Q13 PMBT3904
CR8 HP2800 SMD	IC9 LM324	Q14 MJD31
CR9 MMBD914	IC10 7660 (option)	Q15 PMBT3904
CR10 1N4000 type	K1 G5V or D2N	Q24 PMBT3904
CR11 HP2800 SMD	K2 G6Y	Q26 PMBT3904
CR12 MMBD914	K3 G6Y	VR3 78L05
CR13 MMBD914	M1 SYM18H	VR4 78M05
CR14 1N4000 type	Q1,Q2 NR	VR5 78S09
CR21 MMBD914	Q3 PMBT3904	Y1 NR
F2 71M-3 pole	Q4 PMBT3904	Y2 42.000 Standard
F3 70M-2 pole	Q5 PMBT3904	PTC-50 Thermistor
F4 70M-2 pole	Q6 FPD750	Xtal Shield

Power Meter

BAR1 BAR GRAPH DISPLAY

IC1 LM3914

C1 1000 DISC CAP

R1 2.7K 1/4W RESISTOR

C2 100 μ F ELECTROLYTIC CAP

VR1 10K POTENTIOMETER

C3 0.1 μ F DISC CAP

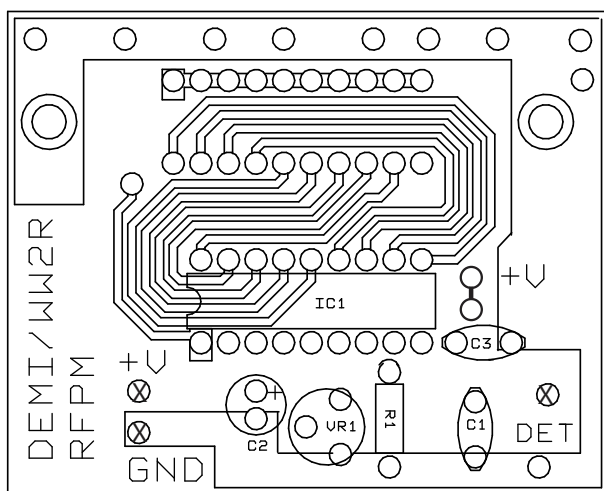
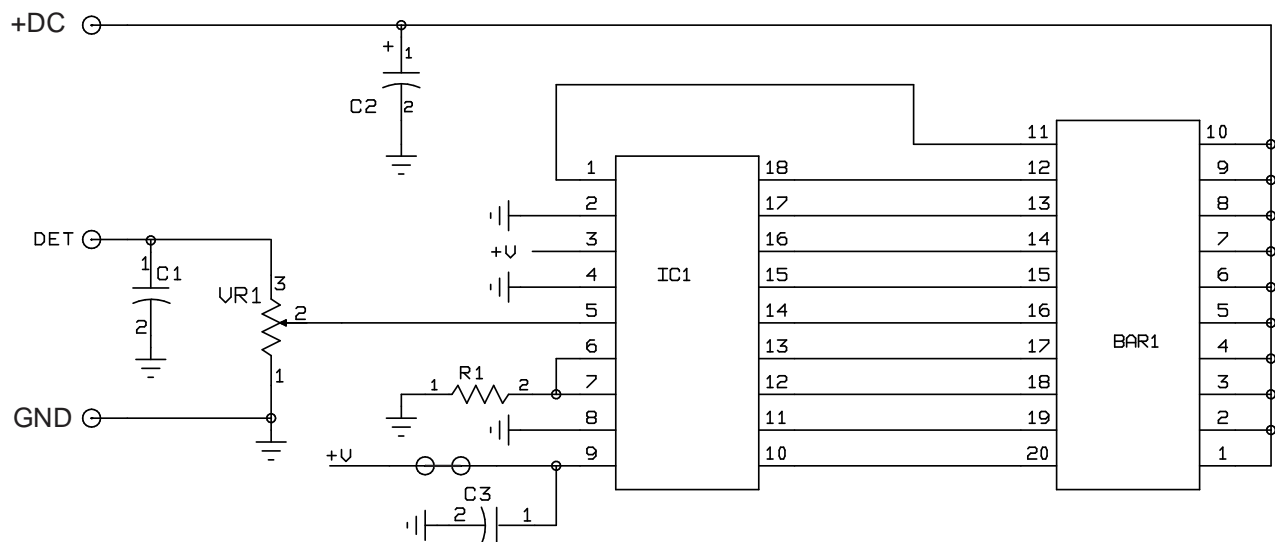

RFPM

TOP SIDE ASSEMBLY

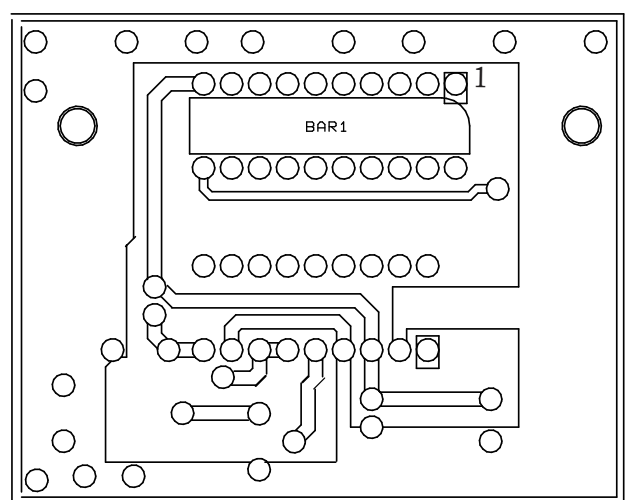

RFPM

BOTTOM SIDE ASSEMBLY

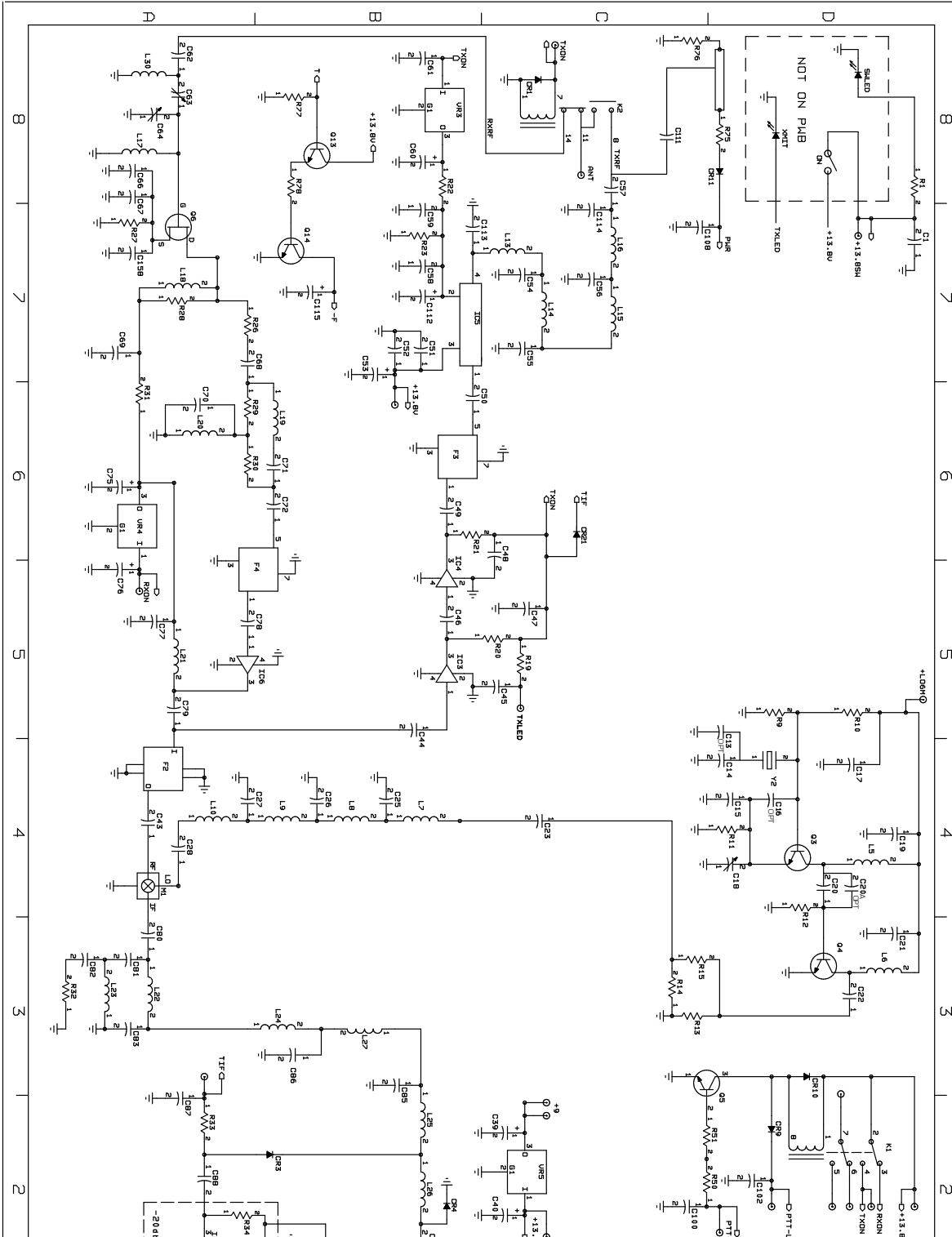

70MHz
Transverter Schematic
01/2012

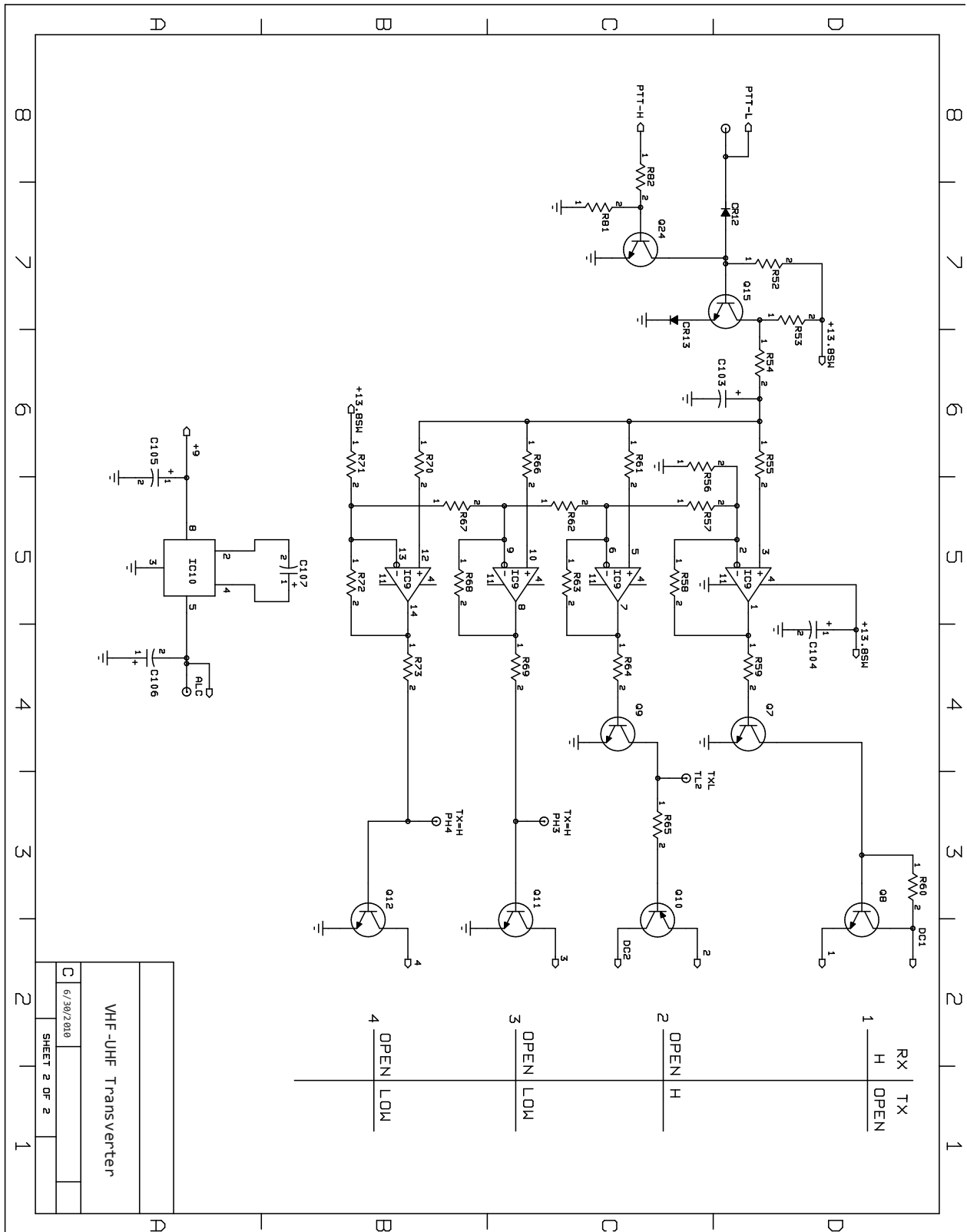
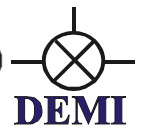
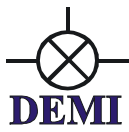

VHF-UHF Transverter	
C	6/30/2010
SHEET 2 OF 2	

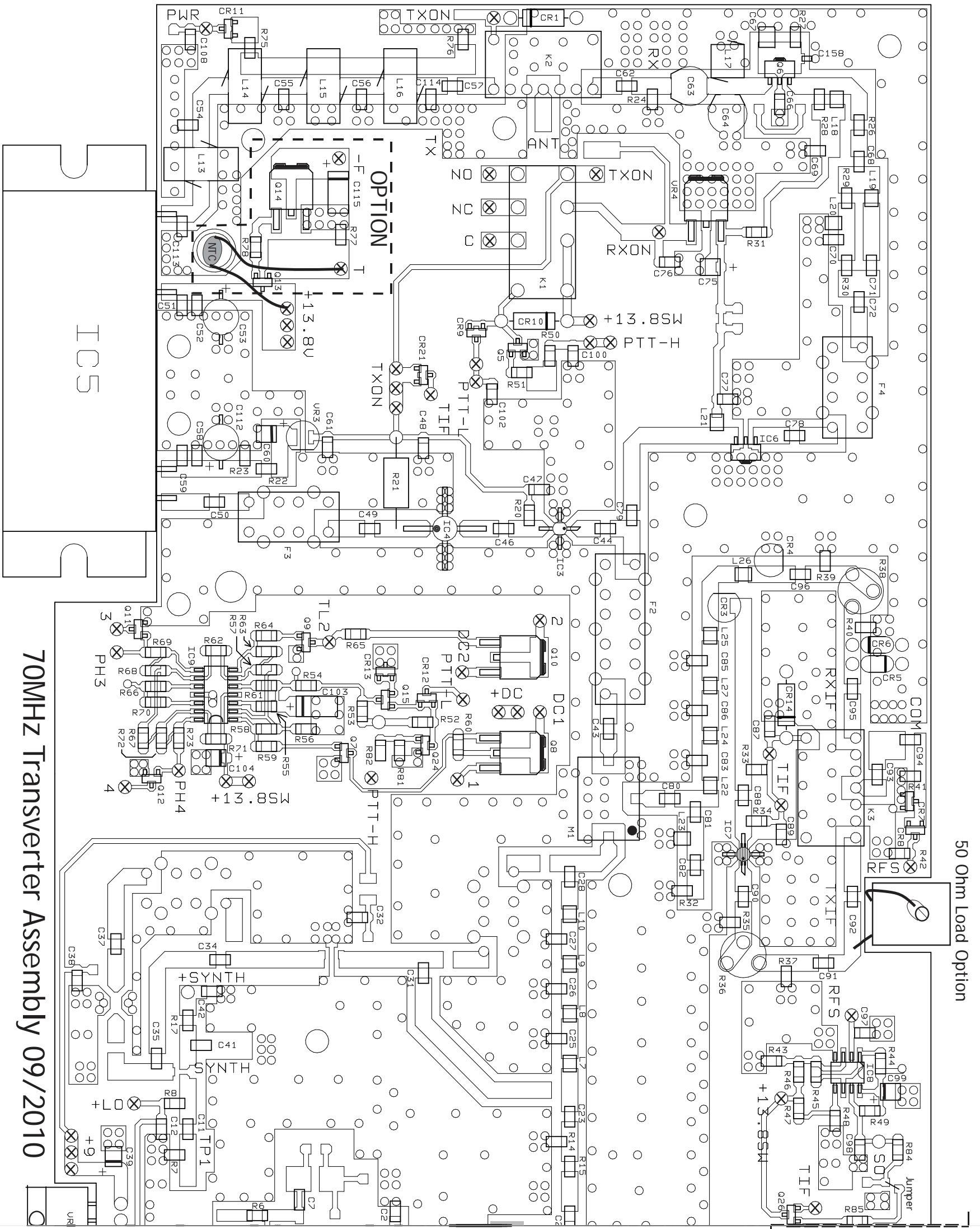

70MHz Transverter Assembly 09/2010

50 Ohm Load Option

OPTION